



OWNER'S GUIDE

• ASSEMBLY • OPERATION • MAINTENANCE • REPAIR PARTS

**SHOPSMITH
MULTI-PURPOSE
POWER
TOOL**

MODEL NO. 10-ER
ART. 25 TMG 3470A-71A
B4(D)-P-6B*

MODEL NO. 10-ER

ARTICLE NOS. 25 TMG-3471A, 3470A

MULTI-PURPOSE POWER TOOL

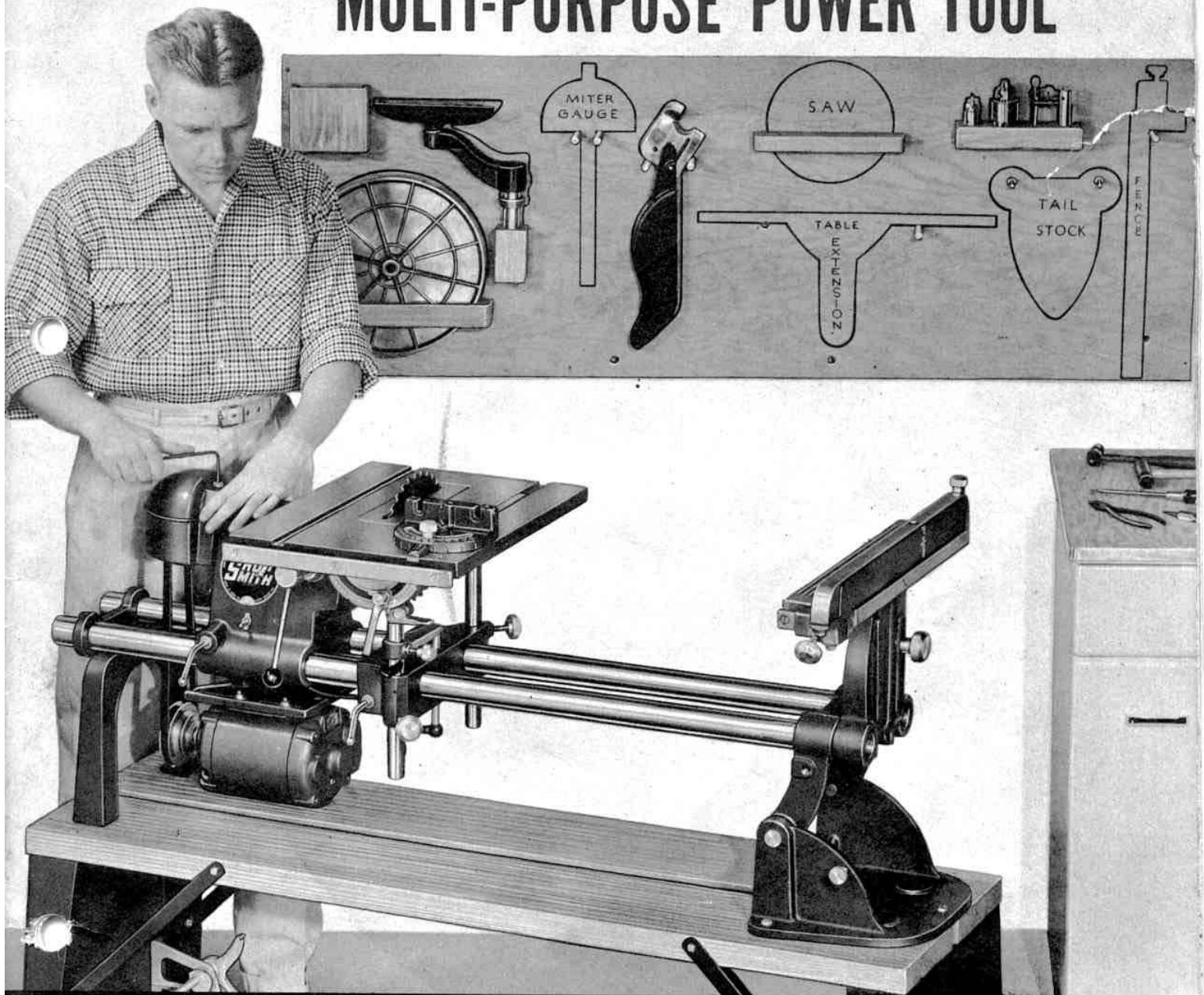

MAGNA ENGINEERING CORPORATION
MENLO PARK, CALIFORNIA

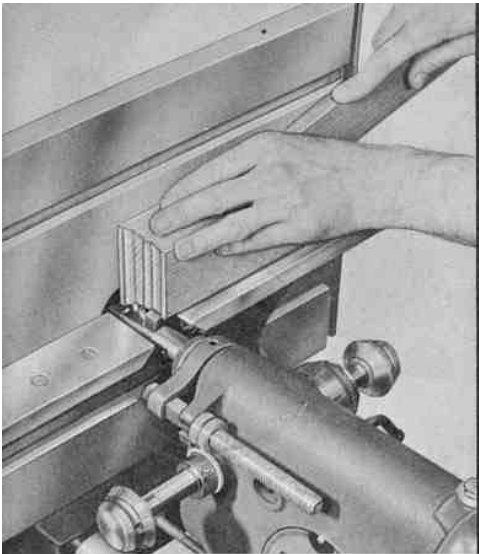

SHAPING, in Horizontal Position

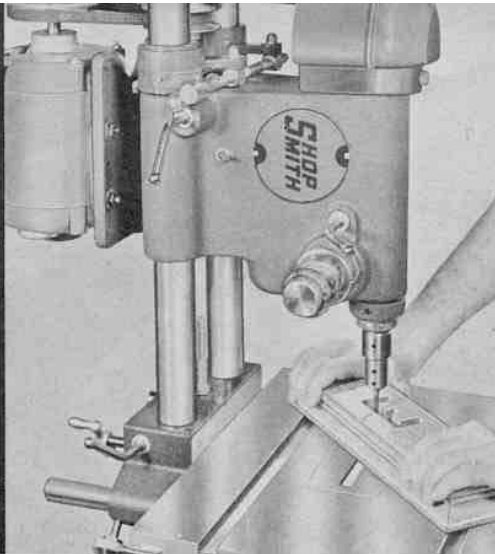

ROUTING, using Variable Speed Changer
INDEX



RABBETTING, with Dado Blade

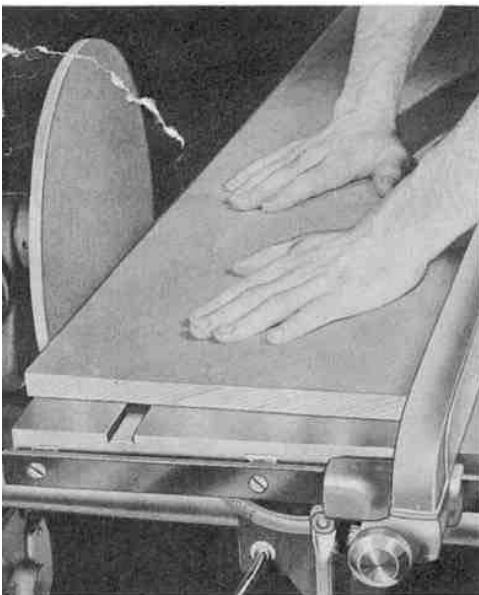

JOINTING, with Disc Sander

ACCESSORIES	20
ADJUSTMENTS	
Pulleys and Belts	5
Tubular Ways	6
Lathe Dead Center	8
Carriage Positioning Stud	10
Saw Table	12
Trunnion Stops	12
Miter Gauge	12
Rip Fence	13
Table Extension	8
ASSEMBLY	
Packing List	3
Setting Up SHOPSMITH	3
DESCRIPTION OF MAJOR PARTS	
Frame	5
Headstock	6
Carriage	7
Table	7
Table Extension	8
Tailstock	8
Pulley Speeds	8
OPERATION	
Circular Saw	9
Disc Sander	13
Horizontal Drill	13
Lathe	8
Lubrication	7
Miscellaneous Applications	14
Repair Parts	18-19
Safety Precautions	15
Vertical Drill Press	13

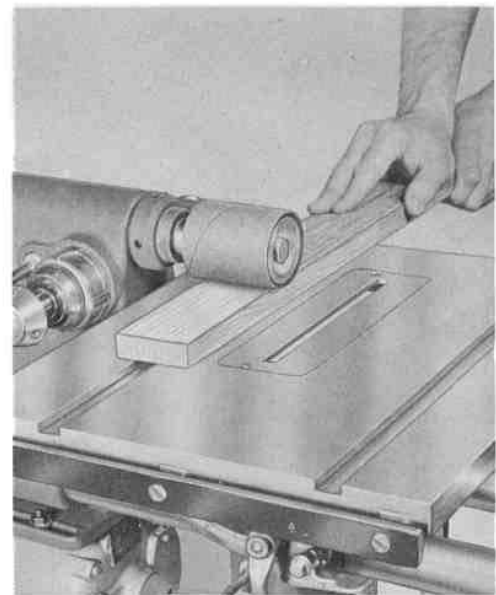

PLANING, with Drum Sander

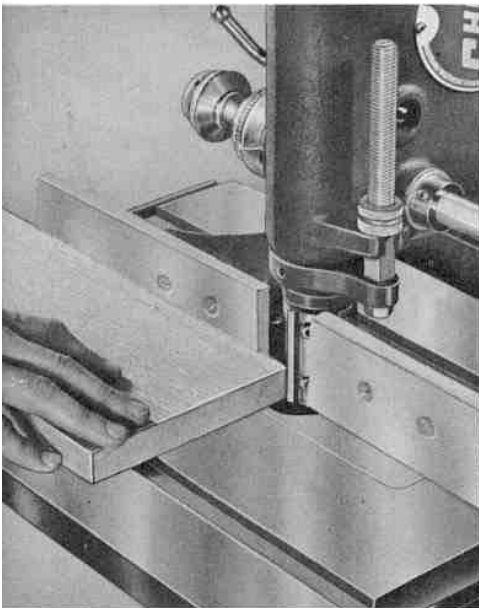

JOINTING, in Vertical Position

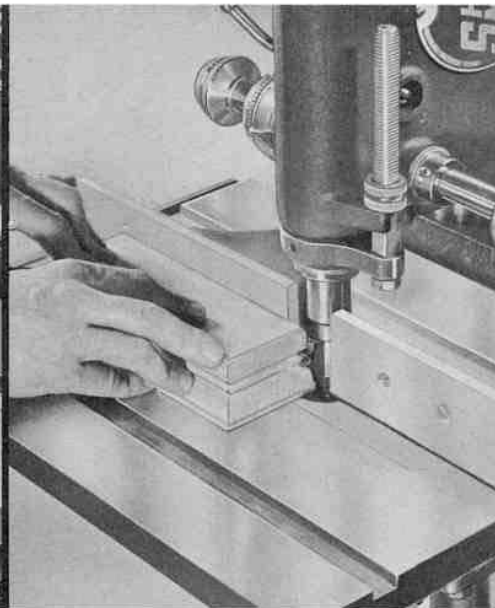

SHAPING, in Vertical Position

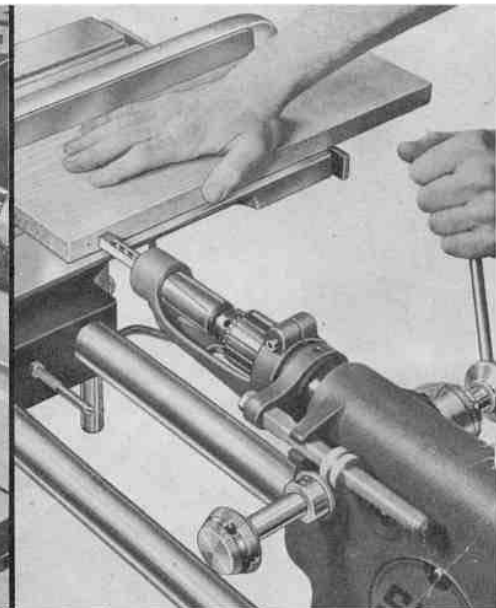

MORTISING, in Horizontal Position

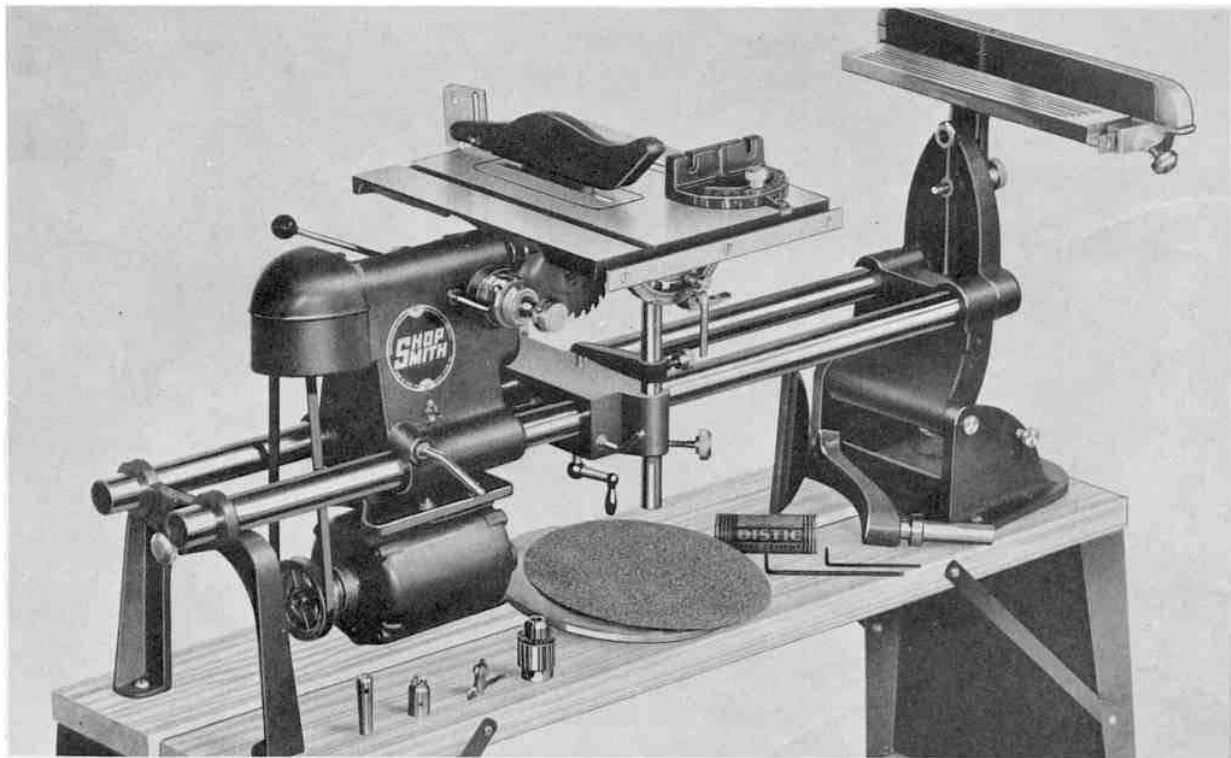

FIG. 1 Shopsmith in circular saw position with all basic attachments.

SHOPSMITH

MULTI-PURPOSE POWER TOOL

ASSEMBLY

PACKING LIST—The crate in which your Shopsmith multi-purpose power tool is received contains the following items (Fig. 1):

1. Basic Shopsmith, complete with Frame Assembly, Headstock, Table Assembly, and Tailstock.
2. Fiber carton containing one each: Headrest, Rip Fence, Miter Gauge, Saw Guard and Splitter, Motor Pulley, Lathe Tool-Rest, Sanding Disc, 8-inch All-purpose Crosscut and Rip Circular Saw Blade, Saw Arbor, Jacobs Key Chuck, Lathe Spur Center, Lathe Tail Center, Feed Lever, Toggle Switch, four Cap Screws for attaching motor to motor bracket, Table Extension Bracket, Table Extension Knob, Table Extension, "V" Belt. Two Cap Screws for attaching Table Extension to bracket.
3. Envelope containing Blueprint and Instructions for constructing a suggested bench and a rack for your attachments, Warranty Card, Owner's Guide and Instruction Book, Shopsmith Shavings, and Accessory Catalog.

Before you do anything else, fill in your Warranty Card and drop it in the mail. With your Warranty Card on file at the manufacturer's, your Shopsmith 1-year guarantee is in effect, you receive, free, a dial speed selector for determining the proper speed for each operation, and you become eligible for future issues of Shopsmith Shavings and other communications from the company on new accessories, etc.

SETTING UP SHOPSMITH—Unpack carefully and check to see that you have all the parts listed above. Do not release any levers or **force** any parts until you have read the following instructions:

Assembly of Shopsmith will be facilitated if you first clean off the rust-resisting compound with which certain parts have been coated for shipment. Use a rag and kerosene and, after all parts have been thoroughly cleaned and wiped dry, cover all unpainted steel surfaces with a thin film of light machine oil to prevent rusting. These surfaces, the tubular ways in particular, should be kept lightly oiled at all times. The table, extension table, and knurled knobs are aluminum and do not require this attention. The entire machine should be protected with a canvas or similar type cover when not in use. This protection is especially recommended when the unit is to be installed in a basement shop.

Because Shopsmith is not a floor-type machine, a suitable base must be provided for mounting it. Shopsmith metal bench ends are available and provide an easily constructed serviceable bench. A blueprint and instructions for making an all wood bench are included in the envelope. The bench should be about 20 inches high; this measurement can be varied to suit individual requirements. The bench top should be strongly constructed and reinforced. If a plywood top is used, be sure it is suitably supported underneath. The bench need not be

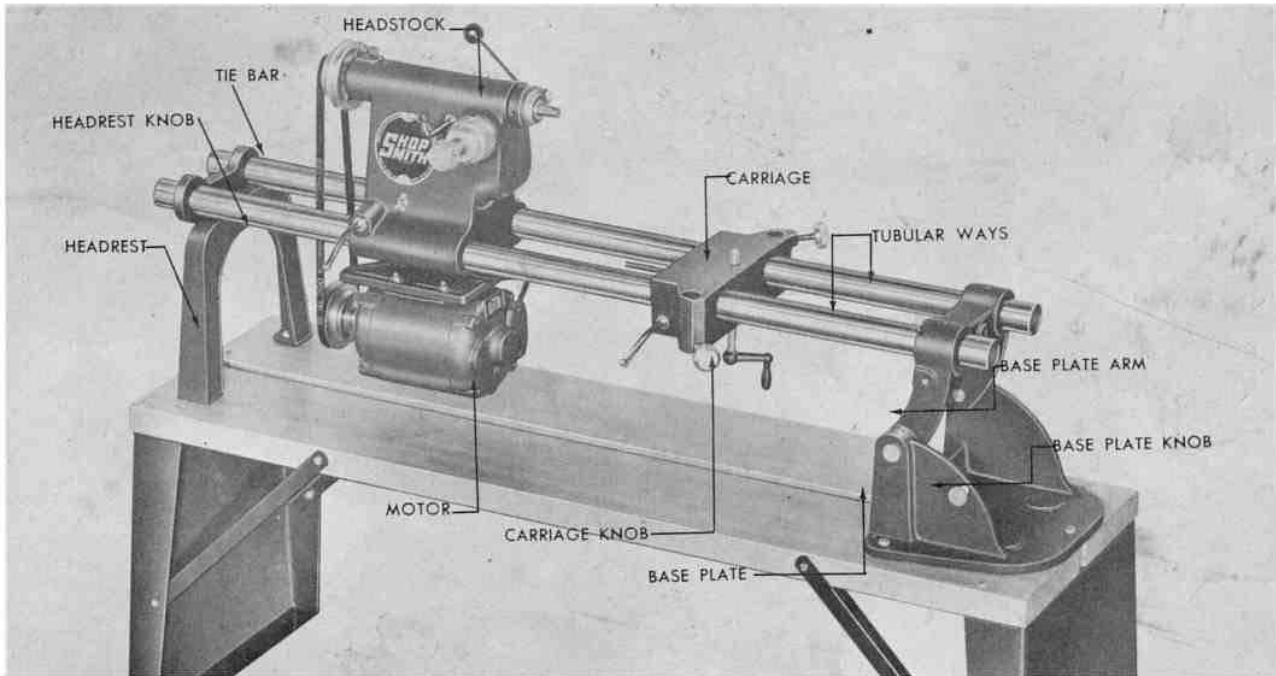

FIG. 2

Shopsmith with all attachments removed.

bolted to the floor since it may be convenient, when handling large stock or long pieces, to shift its position. If mobility is a factor to be considered, casters can be secured to the bench base or metal bench ends; however, they should be retractable to assure rigidity during operation.

With a properly constructed bench provided, the machine can be completely assembled.

For convenience in packing, Shopsmith is secured in its crate in a vertical position. To assemble, loosen the carriage knob (Fig. 2) and pull the table completely free of the carriage. Hold the tubular ways with the left hand (to prevent falling), loosen the base plate knob, and lower slowly until the ways rest on the bench. Unbolt base plate and remove Shopsmith from the crate.

Arrange Shopsmith on the bench top; locate and drill $\frac{3}{8}$ or $\frac{1}{2}$ -inch holes for the base plate and bolt down securely with machine bolts. Drive bolts through from the top side and apply nuts from below with washers between them and the wood top.

It is unnecessary to remove tie-bar for all operations of the machine except outboard turning. If the headstock has to be removed from the ways, it is necessary to loosen the Allen set-screw and slide off the tie-bar. In returning the tie-bar to its position locate the setscrew in the same spot as before to prevent marring of the ways.

ATTACHING HEADREST—Raise the tubular ways and place the headrest on the right side of tie-bar with the extended boss of the headrest on the side touching the tie-bar. Tighten the headrest knob, which then locks tubular ways to headrest. Mark the centers of the headrest bolt holes on the bench top. Do not drill holes at these points but move the center marks $\frac{1}{8}$ inch toward the base plate. (This $\frac{1}{8}$ inch will allow clearance between the tie-bar and headrest when Shopsmith is raised to the vertical position.) Drill $\frac{3}{8}$ or $\frac{1}{2}$ -inch bolt holes. Bolt headrest down solidly.

MOUNTING MOTOR—The special Shopsmith motor has been designed to be easily installed and to give maximum service.

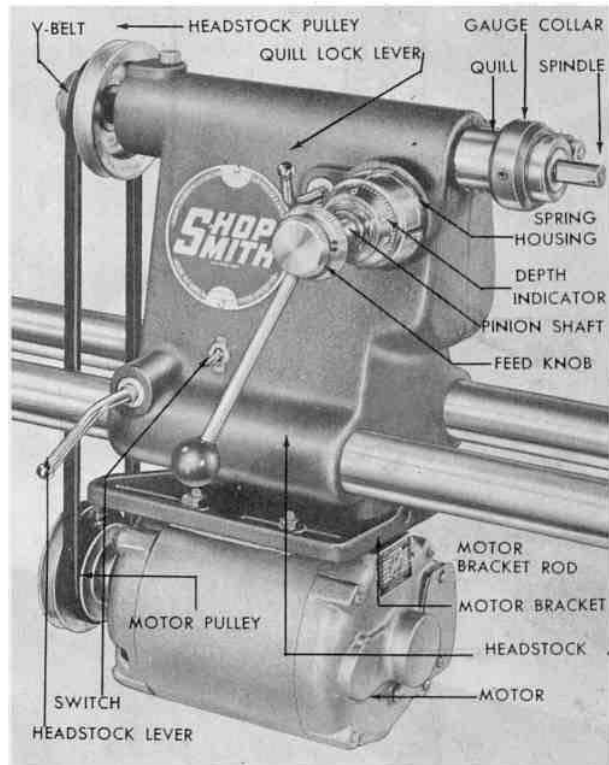

FIG. 3 Headstock and motor with parts designated.

If you do not have a Shopsmith motor, note carefully the following requirements: Shopsmith is designed to be operated by a $\frac{1}{2}$ h.p. capacitor or repulsion-induction ball-bearing motor having a speed of 1725 r.p.m. Though some operations may be satisfactorily performed with a lighter motor, full utilization of this versatile tool can only be obtained by having adequate power. The motor shaft must be ball-bearing mounted

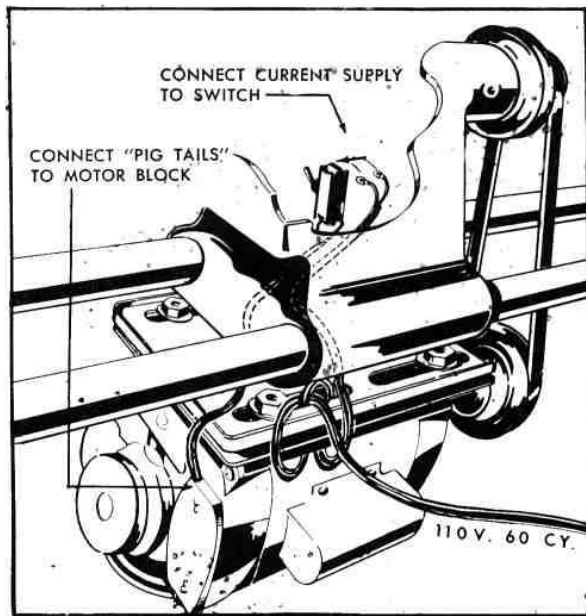

FIG. 4 Motor and switch connections.

To operate in both vertical and horizontal positions, and extreme caution must be taken to prevent sawdust or chips falling into the motor through the vent holes. When using other than the special Shopsmith motor, invert the end caps or shield the vent holes. Also, note that capacitor box should be side-mounted to eliminate interference with the bench.

The motor bracket (Fig. 3) is attached to the headstock by means of Allen setscrews. These setscrews are located at either end of the headstock. Loosen them with the wrench provided and remove the motor bracket. Never loosen the setscrews in the motor bracket itself. Attach motor to bracket with four $\frac{1}{4}$ by 1-inch machine bolts and washers which are included in the carton, but do not tighten bolts until motor has been finally positioned. With Shopsmith in vertical position, insert motor bracket rods into holes on base of headstock and hold motor bracket in place by tightening the Allen setscrews. Lower Shopsmith to horizontal position.

ATTACHING MOTOR SWITCH—Loosen the motor bracket setscrews and lower the bracket and motor to leave an opening of approximately 2" between the bracket and the headstock. Remove the bottom screw in the nameplate, and pivot the nameplate around the upper pin. This reveals a hole beneath the nameplate which facilitates insertion of the switch. Before attaching the switch the necessary connections should be made.

The Shopsmith motor is equipped with a short lead wire to connect with the switch. If you do not have a Shopsmith motor, use an 18-inch length of No. 18 rubber-insulated cord. Thread short wire through the motor bracket slot and connect to the switch, as shown (Fig. 4). Then insert the terminal end of the long lead cord through the motor bracket slot and make a loop knot (see Fig. 4) to take up strain which would otherwise be placed on switch connection. Secure all terminals to switch.

DESCRIPTION OF MAJOR PARTS

To understand and appreciate what Shopsmith can do, you should be familiar with the principal parts and their uses. Carefully observe the brief descriptions and illustrations that follow:

FRAME ASSEMBLY—is the basic structure (Fig. 2). It consists of two centerless-ground steel tubes, base plate, base plate arm, tie-bar and headrest. With the exception of the tubes and

Remove both threaded lock-nuts and ON-OFF plate from the shank of the switch. Insert the switch between the motor bracket and headstock and put your hand through nameplate opening to guide the switch into the hole provided for it in the headstock. Replace ON-OFF plate and run the lock-nuts down hand-tight temporarily.

Do not tighten the switch in its final position until the OFF position of the toggle lever points toward the tubular ways. Installation of the switch in this way is a safety precaution and prevents accidental contacts from turning on the power.

Replace nameplate screw and proceed as shown in the following section.

ADJUSTING PULLEYS AND BELTS—Attach motor pulley (small pulley closest to motor) on the motor shaft. With Shopsmith in its horizontal position—be sure setscrews on motor bracket rods are tight—align motor pulley with headstock pulley by adjusting motor until the two are in line. Tighten motor to bracket, but do not apply belt to pulley until motor wires have been connected to lead wire and switch and the motor tested for correct rotation. Motor should run clockwise when viewed from the motor pulley end (Fig. 2).

Rotation of motor can be changed on capacitor-type motors by removing cover from the terminal box and reversing the field-winding terminals to opposite binding posts. In the case of repulsion-induction motors, rotation is reversed by moving the brush holders to one side or the other of a witness mark on the brush holder mounting. If there is any doubt, refer to the wiring diagram of connections supplied with motor or information given on the motor nameplate.

With correct rotation of the motor established, apply the V-belt. If the motor used has a larger diameter than the standard Shopsmith motor, a longer V-belt may be required—due to the difference in the center distance between shaft and motor bracket.

Belt tension can be increased or diminished by adjusting motor bracket rods in the headstock. Belt should be sufficiently tight so that it will not rub against ways at any pulley speed.

Avoid excessive belt tension, which will impose a damaging load on bearings, shorten belt life and waste power. Also, note that the motor and headstock pulleys should be **accurately aligned**. This can be readily accomplished by using a carpenter's square, with one leg lying on the table and the other against the two pulleys.

CAUTION: Should spindle bearings heat up, check belt tension **immediately**. Remember that the belt should be tightened sufficiently so that it will not rub against the tubular ways, but not so tight that the belt cannot be deflected approximately one inch by applying reasonable pressure against it at a point opposite the ways.

STORING ATTACHMENTS—Shopsmith will perform most efficiently if some provision is made at once for properly storing the interchangeable parts on hooks, shelves, racks or cabinets where they will be convenient to the basic unit. In addition, take the usual precautions against accidental damage and corrosion.

headrest, all of these parts are high-quality cast iron, precisely bored in fixtures that assure their permanent alignment.

The headstock and carriage can be removed from the ways by releasing Allen screws on each side of the tie-bar and sliding off the headstock and carriage. The tubular ways have been factory-aligned but, if they should be loosened, re-align them as follows:

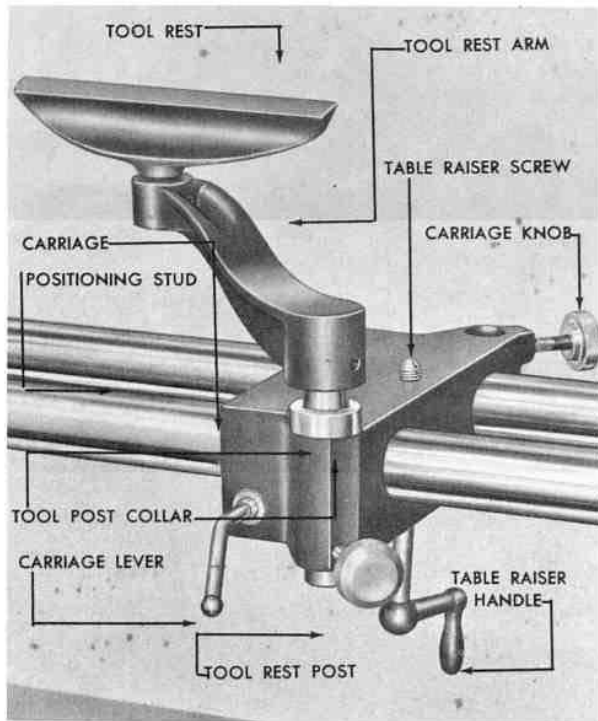

FIG. 5 Tool rest and carriage with parts designated.

Raise ways to vertical position and lock with base plate knob. Loosen Allen screws in base plate arm and slide tubes down until they rest on the base plate, lock Allen screws.

CAUTION: Maintain tubular ways with care. Tools and heavy pieces of work falling on or striking tubular ways will raise burrs that prevent headstock and carriage from sliding freely. Any such burrs should be carefully smoothed down. Wipe abrasive dust or metal chips from the ways before sliding carriage or headstock. **Always keep ways protected from rusting by a thin film of oil.**

HEADSTOCK — Shopsmith headstock (Fig. 3) is the key operating unit and contains the headstock spindle-shaft and bearings, quill, pinion shaft and gear, pulley shaft and bearings. Since the bearings are of the grease-sealed type, it should never be necessary to disassemble the headstock. If, however, adjustment or replacement ever should be required, components can be disassembled as follows:

To remove pulley bearing-assembly, remove pulley guard and belt, loosen Allen screw and pull out total assembly; to remove quill assembly, unscrew nut from depth stoprod and wind out with feed lever. This must be done slowly and carefully so that spring will not unhook from its seat.

CAUTION: Ball bearings can be easily injured or ruined by improper handling. The ball bearings used in Shopsmith should not be changed without proper tools. If a bearing needs replacement, return the entire drive sleeve assembly, or the

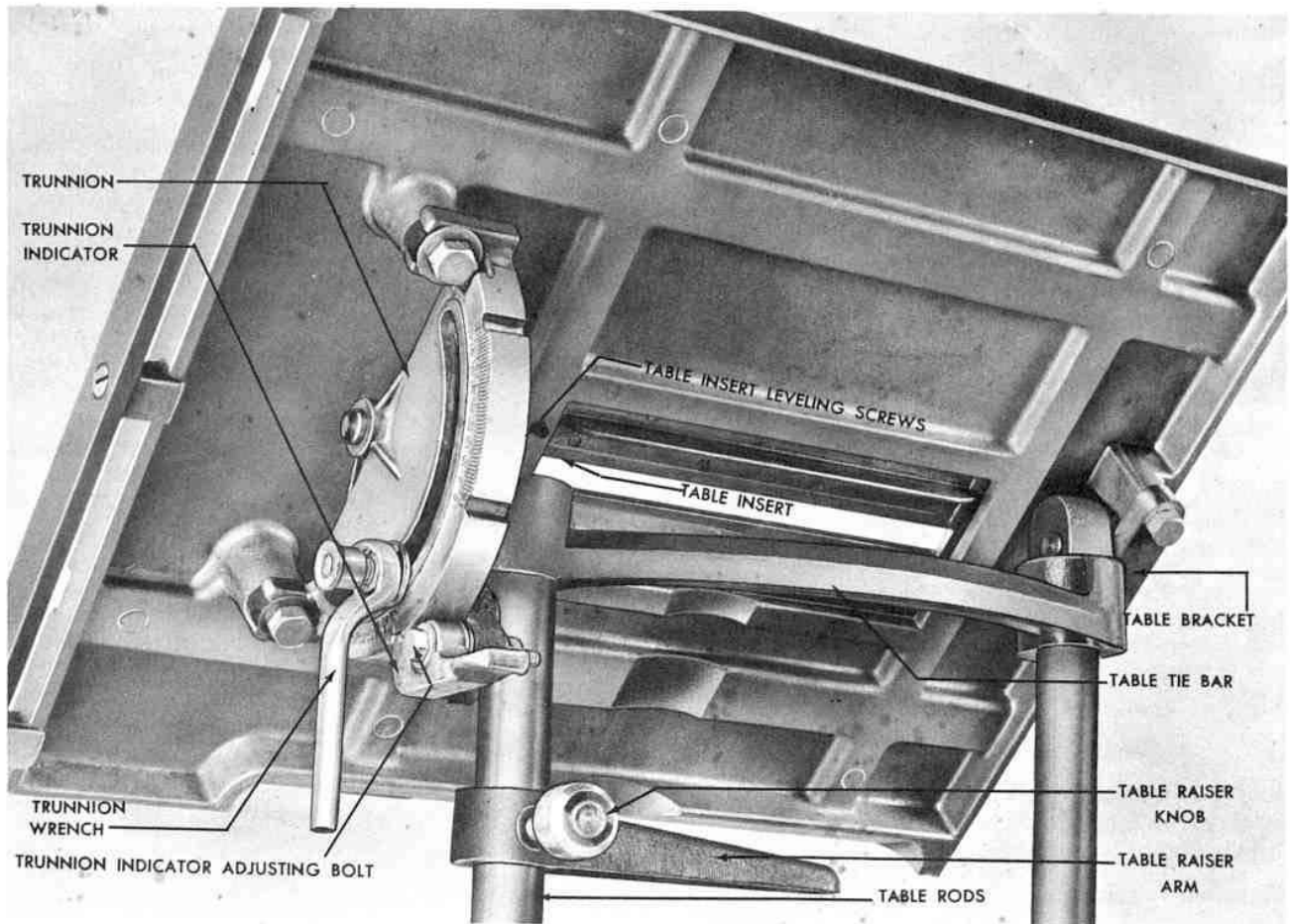

FIG. 6

Underside of saw table (tilted) with parts designated.

spindle and quill assembly, to your dealer who will arrange for factory repair.

The headstock spindle is supported by ball bearings at either end of the quill, which is a movable steel sleeve. When the feed lever is turned, a simple rack-and-pinion gearing moves the quill and the spindle it supports.

When pressure on the feed lever is released, a coil spring returns the quill and spindle to their normal, retracted position. This spring is enclosed in a metal case on one side of the headstock. Spring tension is adjusted at the factory; if a different tension is required, adjust as follows:

Remove nut from depth stop-rod; turn feed lever until quill rack disengages from pinion gear. Keep turning feed lever until desired tension is obtained. Remember that the external spline on the spindle and internal spline on the pulley shaft must mate; hold the pulley and turn spindle slightly when reinserting the quill and spindle.

LUBRICATION—To maintain quiet and smooth spindle and quill operation, regularly place a few drops of medium-weight machine oil on the outside of the quill. Extend the quill its full length and force a small amount of cup grease into the splined section of the spindle and drive shaft. Release the quill and work it back and forth to distribute the lubricant evenly. Headstock "chatter" can nearly always be eliminated by greasing the spline.

CARRIAGE—The precision-bored carriage (Fig. 5) is locked at any position on the ways by the carriage lever, which applies soft metal wedges against the tubes. Carriage knobs on either side secure the table or lathe tool-rest at desired height.

CAUTION: Be sure that both carriage lever and knobs are tightened before starting any operation.

The stud extending from side of the carriage facing the headstock automatically (after initial adjustment) stops the carriage in the correct position in relation to the headstock for using the circular saw.

TABLE—Shopsmith's precision finished aluminum table (Fig. 6) is supported on the carriage by two steel rods, and the adjustment is held by the carriage knobs. The table can be tilted from 45 degrees in one direction to 90 degrees in the opposite direction. Shopsmith table can be rapidly raised or lowered, with precision adjustment by using the table raising screw.

Table trunnion (Fig. 6) permits the table to be tilted and locked at any desired angle. To tilt the table, loosen the trunnion nut with the trunnion wrench. Then depress the trunnion lever and tilt the table to the desired position. Automatic stops are provided at the most frequently used positions.

The table insert can be removed to accommodate dado heads and formed cutters if desired. Insert is leveled flush with surface of the saw table by adjusting Allen screws on under side. Two table slots allow the miter gauge to be used on either side of the saw blade. The Shopsmith exclusive miter gauge design permits rapid attachment or removal of a miter gauge face extension.

The saw guard and splitter (Fig. 7) combines clear view of the work with utmost safety; it can be adjusted to conform to any position of the table by releasing screw on back of table.

CAUTION: Use the saw guard and splitter for all sawing operations.

TABLE EXTENSION—The table bracket knob and stud screw holds the table bracket to the tailstock (Fig. 8). The bracket slides up and down in the machined channel on the back of

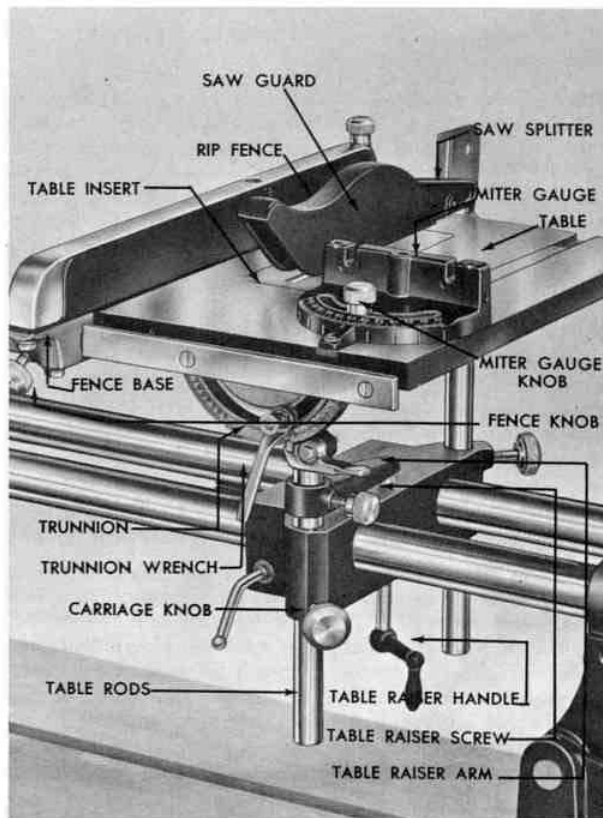

FIG. 7 Saw table and attachments with parts designated.

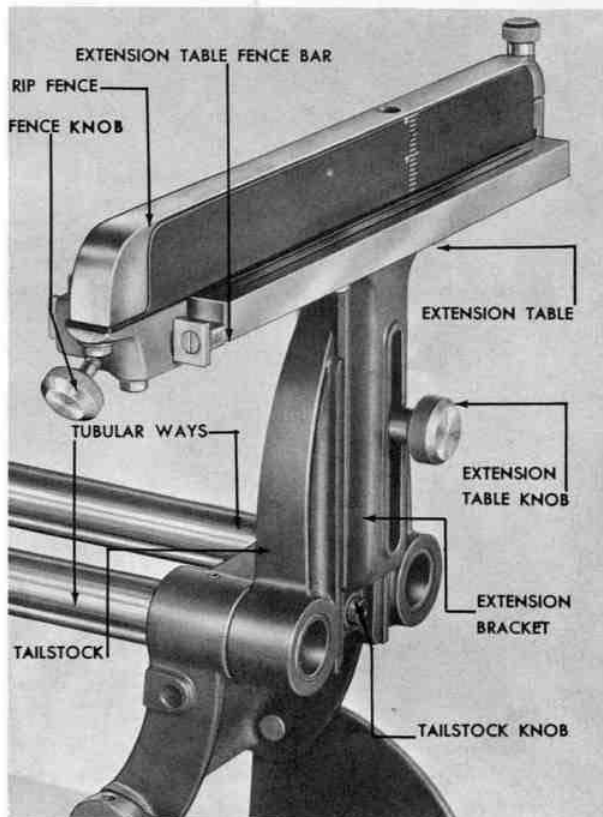

FIG. 8 Tailstock and table extension with parts designated.

the tailstock. The table extension has a fence bar to which the regular fence may be attached.

Table extension should be squared vertically and horizontally to the saw table before final bolting down. Level and lock both tables next to each other and slide rip fence across fence bar so that it is half on the saw table bar and half on the extension table bar. Tighten the fence knob and then bolt down the extension table. The bracket holes through which the table extension is bolted to the bracket are oversize. This permits the extension and bar to be rotated slightly and aligned with the saw table.

TAILSTOCK—When used as a lathe in spindle-turning operations, Shopsmith departs from the conventional by using a fixed tailstock (Fig. 9) and a movable headstock. A "floating" sleeve bored to a No. 2 Morse taper is factory adjusted to align the cup center with the headstock drive center. Should this sleeve get out of alignment it may be readjusted as follows: loosen the large hex nut on the back of the tailstock; bring the points of the cup and drive centers together by moving headstock up to the tailstock; retighten the hex nut.

PULLEY SPEEDS—Matching three-step cone pulleys on motor shaft and headstock spindle provide the necessary high (3450 rpm), intermediate (1725 rpm), and low (850 rpm) speeds (Fig. 10). This range of speeds provides relatively wide latitude but, while the following operating speeds for various operations are suggested, it will be best to use the lower speed on any questionable job until experience determines use of a higher speed. The variable speed changer, a standard Shopsmith accessory, is available and will provide speeds of infinite range from 425 rpm to 6800 rpm.

WOOD TURNING — PULLEY SPEEDS			
DIAMETER OF WORK	ROUGHING CUT	GENERAL CUTTING	FINISHING
Under 2 in.....	2	2	3
2 to 4 in.....	1	2	3
4 to 6 in.....	1	2	2
6 to 8 in.....	1	1	2
8 to 10 in.....	1	1	1
Over 10 in.....	1	1	1

OPERATION WOOD-TURNING LATHE

When used for spindle turning (all work turned between centers, see Fig. 9), square both ends of the work and locate center on each end. If hardwood, drill a small hole at each center point and make shallow diagonal saw cuts across the end to be driven by the spur center. Do not drive work onto the center.

Remove the spur center from the spindle and drive it into a firm seat in the wood with a mallet. Replace spur center on spindle and tighten setscrew. Be sure tailstock knob is tightly locked. Position and lock headstock on the ways so that the distance between centers will be approximately $\frac{1}{4}$ " greater than the length of stock to be turned. Locate the work between centers and advance quill feed lever to seat centers solidly; turn work by hand to see that it does not bind and tighten quill lock lever. Apply a drop or two of oil to the tailstock center before or after centering work.

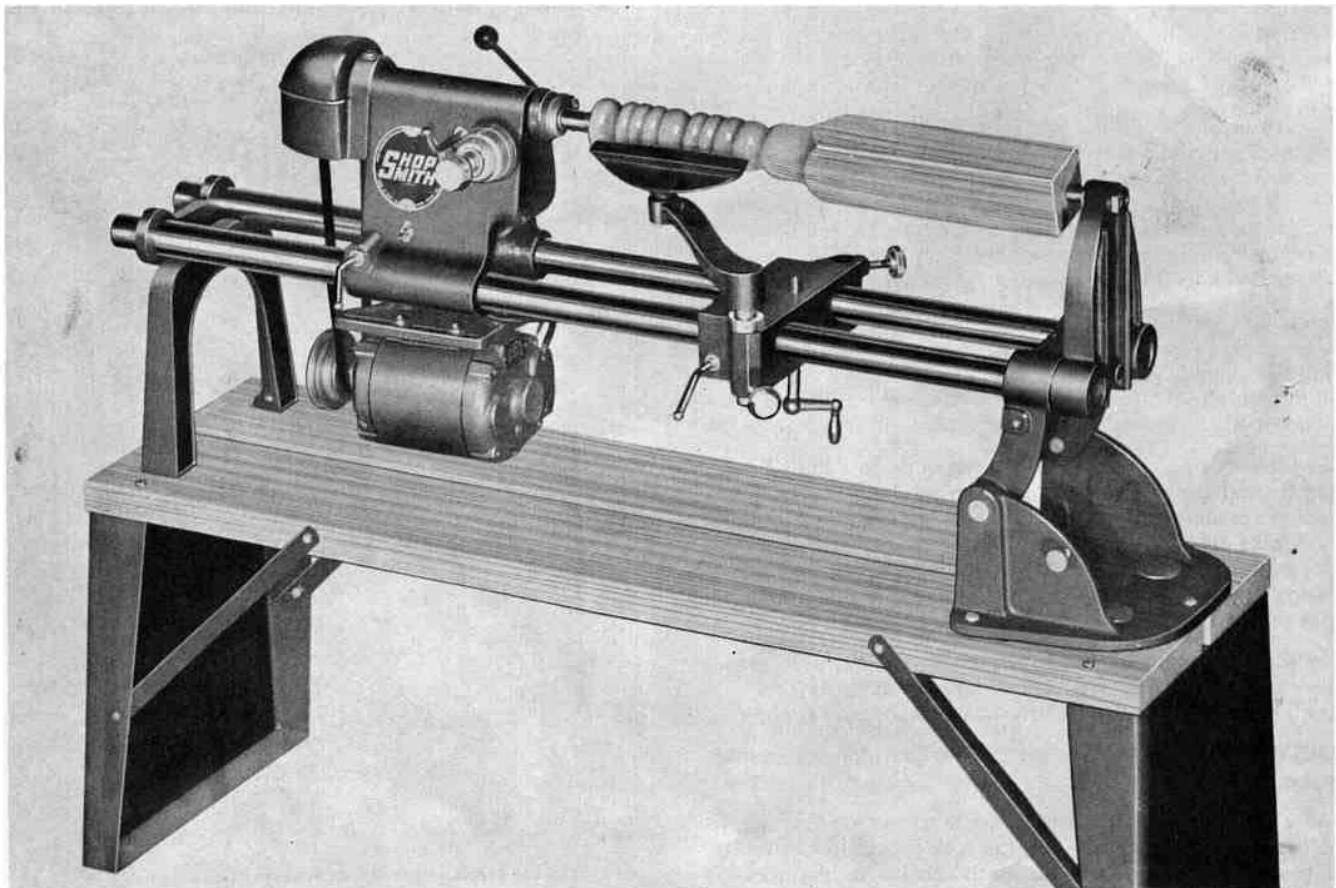

FIG. 9 Shopsmith set up for lathe spindle turning.

The tool-rest (Fig. 5) is seated in carriage hole nearest the operator. A collar on the tool-rest rod is factory adjusted so that tool-rest is about $\frac{1}{8}$ " above lathe center line when the collar is seated on the carriage. This can be adjusted to meet personal preference. In moving the tool-rest up to the work leave a clearance of about $\frac{1}{8}$ ".

CAUTION: Always turn work by hand to see that it clears the tool-rest before starting motor.

FACEPLATE TURNING—If the work to be turned cannot be held between lathe centers, it is generally mounted on a faceplate (Fig. 10) or chuck. Shopsmith faceplates are recommended, available in $3\frac{3}{4}$ " and 6" diameter sizes.

The tool-rest is easily turned parallel to the work. By removing the tailstock and then moving carriage and headstock to the extreme right position, the operator can face the work directly.

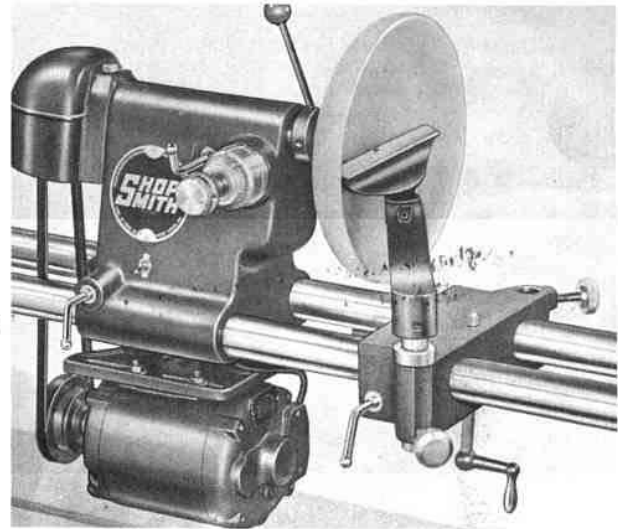

FIG. 10 Shopsmith set up for lathe face plate turning.

CIRCULAR SAW	PULLEY POSITION
8-in. All Purpose Blade	3
SANDING AND GRINDING	
12-in. Disc Sander	2
3-in. Drum	2
4-in. Grinding Wheel	3
6-in. Grinding Wheel	3
Buffing and Polishing (cloth wheel)	3
Scratch Brushing (rough finish)	1
Scratch Brushing (smooth finish)	3
DRILL PRESS	
Wood Boring (Bits to $\frac{1}{2}$ in.)	3
Wood Boring (Bits to 1 in.)	2
Wood Boring (Bits over 1 in.)	1
Mortising (Hardwood)	2
Mortising (Soft wood)	3
Routing	3
Shaping	3

CIRCULAR SAW

Shopsmith, when used as a saw, is designed for use with an 8-inch saw blade with $\frac{5}{8}$ " arbor (Fig. 12). Smaller blades can be used, but the table slot will not accommodate larger ones. To attach saw blade, push the arbor onto the spindle as far as it will go and tighten setscrew against flat side on spindle.

(NOTE: All attachments used on the spindle should be located so that their setscrews, when tightened, will seat against this "flat"; otherwise, the spindle may be burred and attachments cannot be applied or removed freely.)

CAUTION: The user is cautioned not to make adjustments while the saw is in motion.

Place blade between washers (recessed side next to blade) large washer first with teeth pointing toward operator standing at front of table, with pulley or drive to the left hand side. Tighten nut.

Place saw table rods into carriage holes and lower to the point where they can be locked by the carriage knobs. Locate

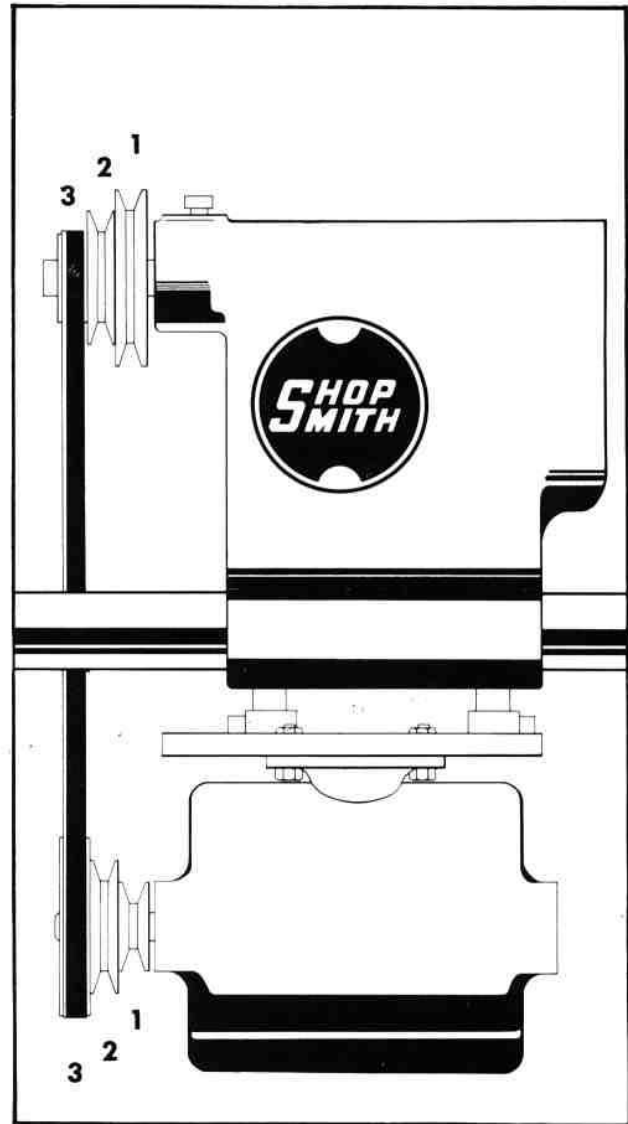

FIG. 11 Shopsmith pulley belt positions.

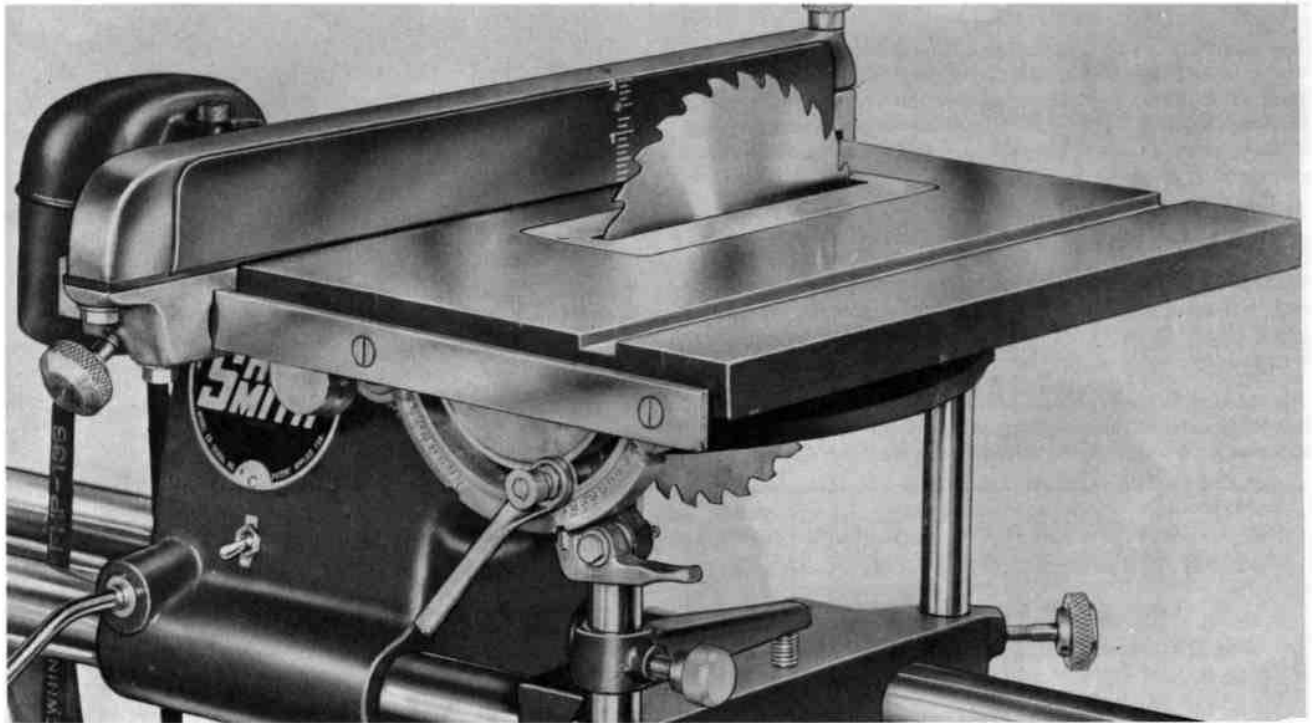

FIG. 12 Shopsmith saw table set in 0° position.

headstock at desired point on the ways and lock with headstock lever; slide carriage toward headstock until saw blade is directly below slot in table insert. When this location has been established, adjust the stud attached to front of carriage so that it just touches the headstock. Thereafter, or until the blade is changed on the saw arbor, this bolt will serve as an automatic stop for correctly positioning the table in sawing position.

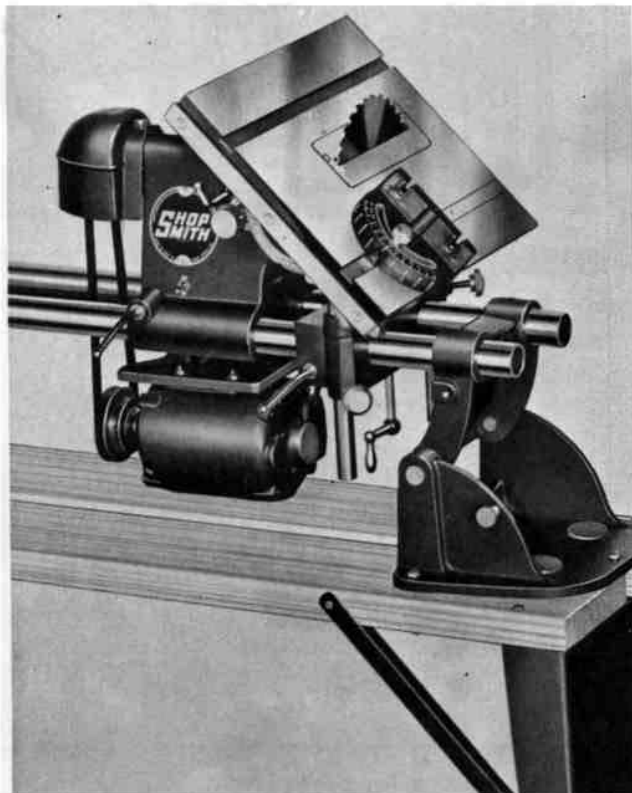

FIG. 13 Shopsmith saw table tilted for 45° bevel cut.

Shopsmith is equipped with a table micro-raising mechanism (Fig. 12). Make rapid adjustments of table height by simply lifting or lowering the table; gripping the front table rod sometimes facilitates control of table descent. To make micro-adjustments of table height, first secure front carriage knob. Then release knob on table raising arm and lower until it fits over top of table raising screw; tighten knob. When the front carriage knob is released, the table can be raised or lowered by turning the ball-crank below the carriage.

NOTE: To slide the table raising arm up, it may be necessary to slightly loosen the table raising screw.

Always be sure both carriage knobs and carriage lever are locked before starting motor.

When tilting the table, note that because the pivot center of the table is below the table top, the saw slot will move in an arc; therefore the quill must be advanced and locked. This may be accomplished either by extending the quill at the same time as the table is being tilted or by raising the table to clear the blade while the adjustment is being made.

The rip fence is smoothly finished on both sides and can be used on either side of the saw. Adjustment is held by tightening front and back fence knobs. Use calibrations engraved in fence side for gauging depth of cut.

Double miter-gauge grooves on the table allow cutting right- or left-hand miters. Gauge pivots to 60 degrees in either direction. A quick-change wooden miter gauge extension and a miter gauge stop rod are available as standard Shopsmith accessories.

CAUTION: Miter gauge should be used only on right side of saw when table is tilted.

The exclusive table extension feature (Fig. 14) gives the Shopsmith the largest effective table of any 8-inch bench saw. Attached to the lathe tailstock by a knob and studscrew, the extension table can be adjusted to the height of the saw table, either by sighting along the main table or, more accurately, by sliding the carriage and headstock together to the tailstock and adjusting extension to table height.

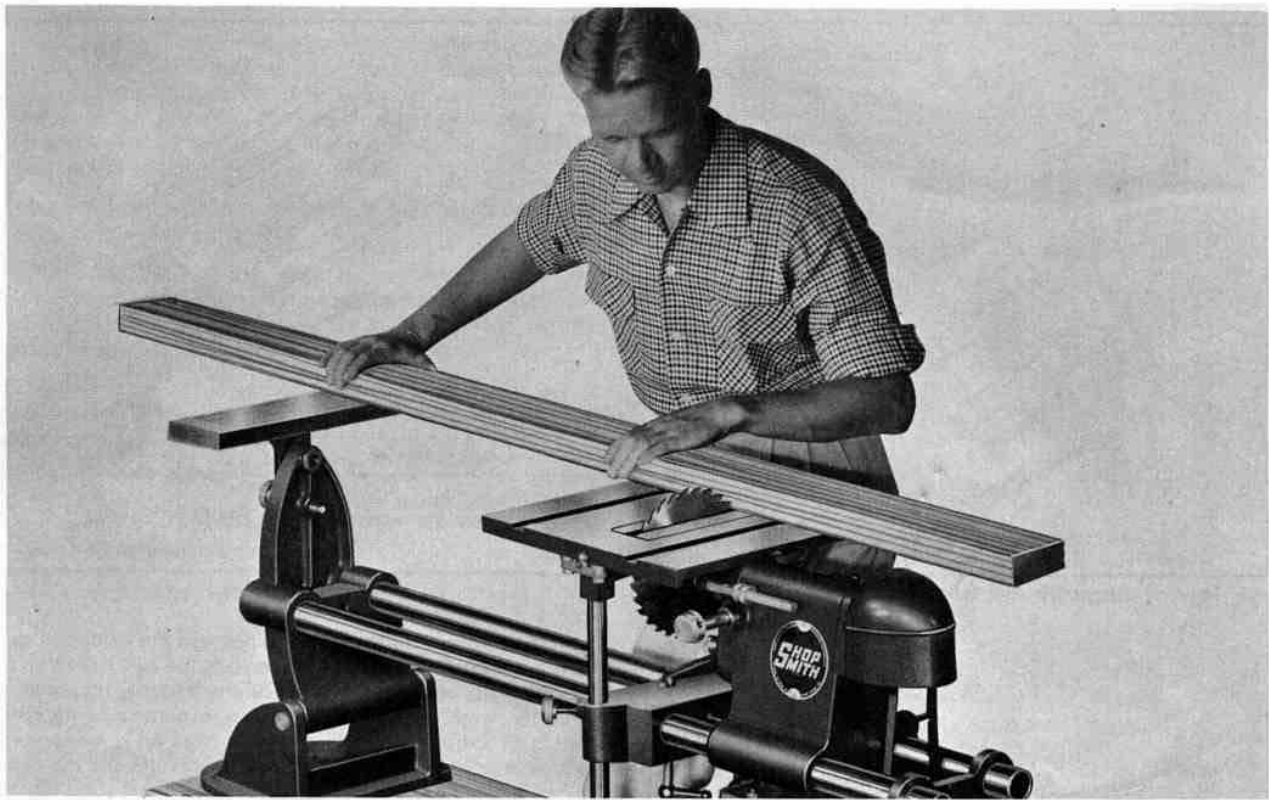

FIG. 14 Crosscutting long board using extension table for support.

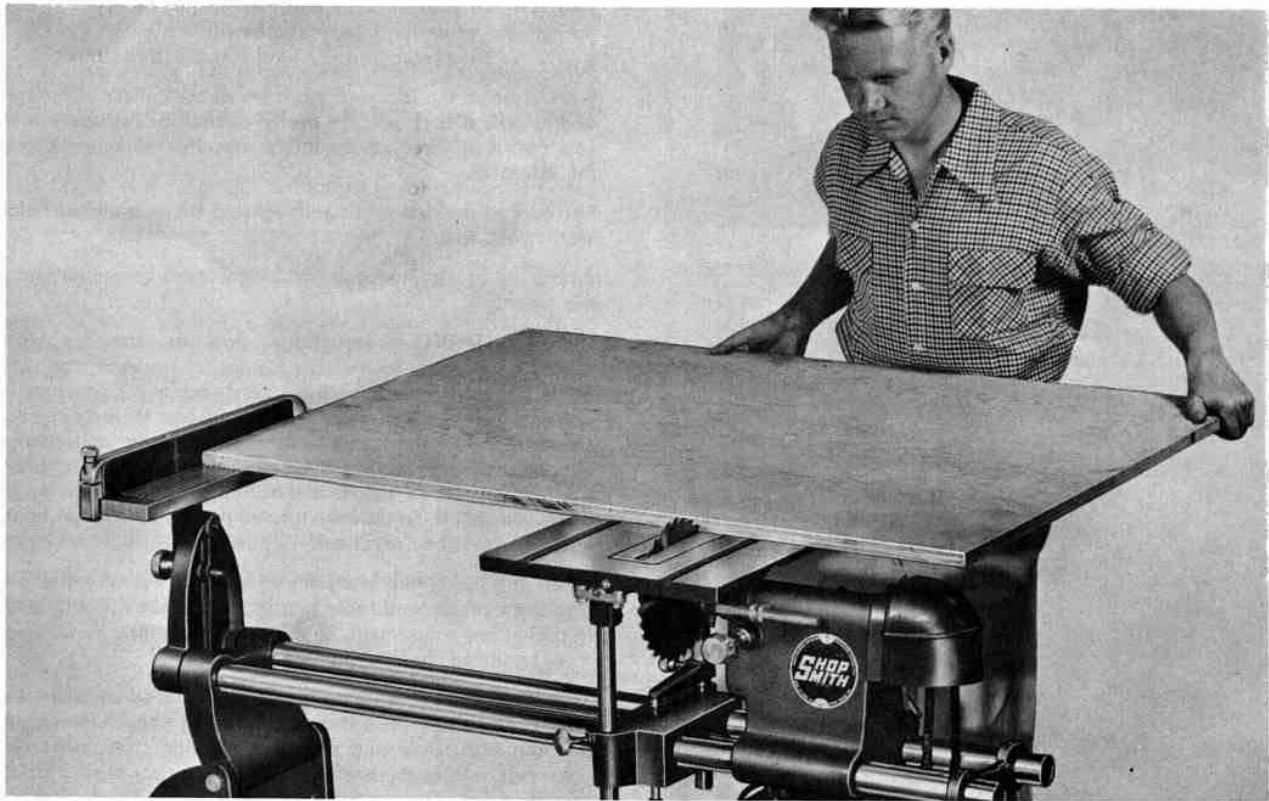

FIG. 15 Ripping wide panel with fence located on extension table.

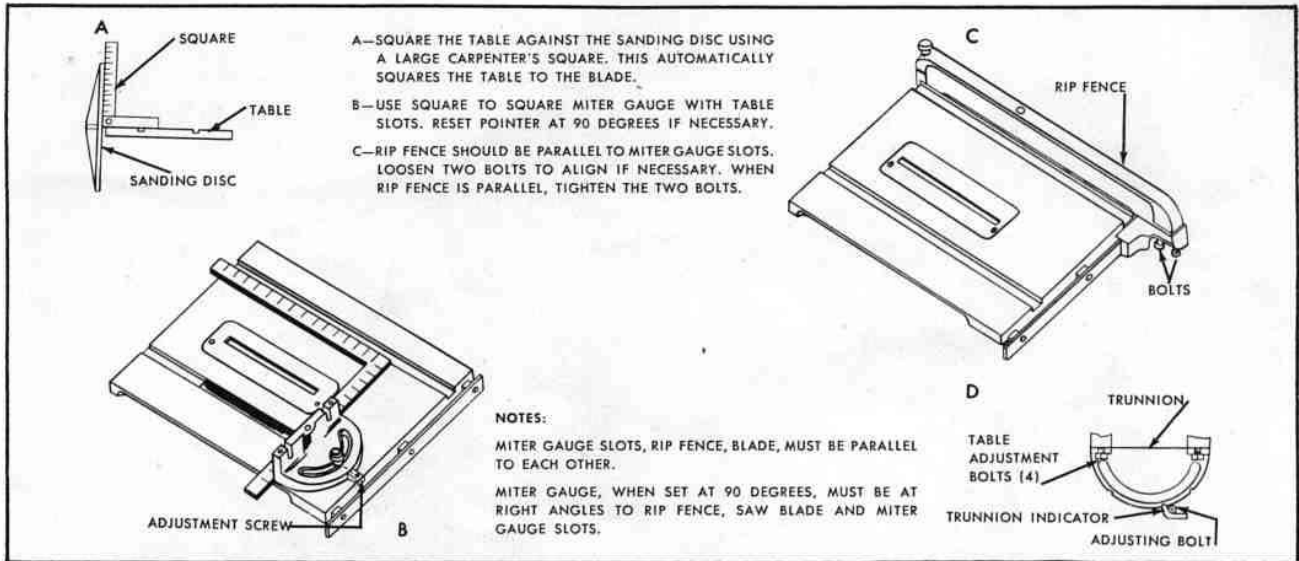

FIG. 16 Shopsmith saw table adjustments.

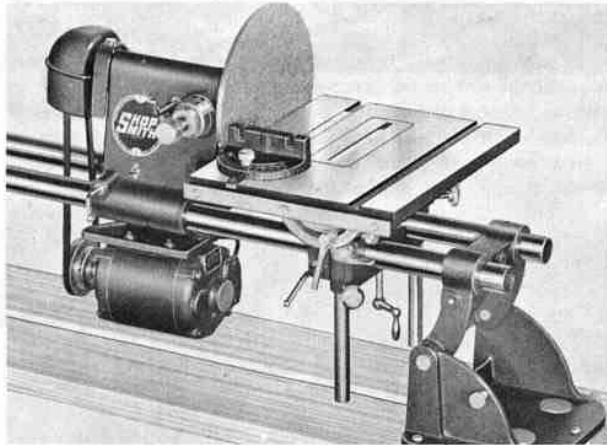

FIG. 17 Shopsmith set up as disc sander.

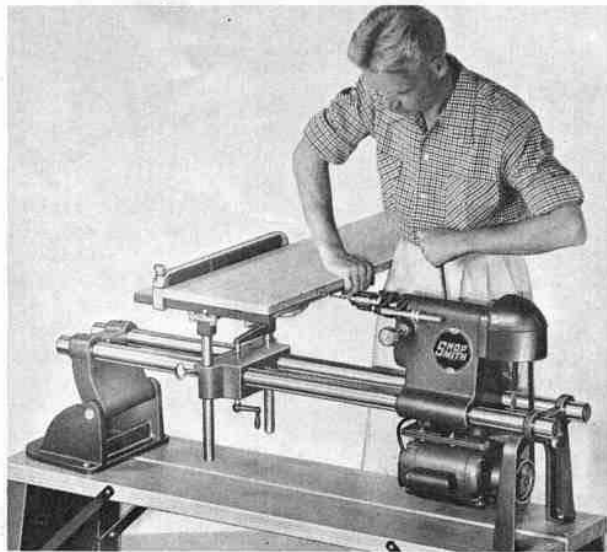

FIG. 18 Drilling for dowelling in horizontal position using rip fence as back-stop.

For crosscutting with the miter gauge, use the extension as a work rest. In making angle or miter cuts, be sure thumb screw lock on miter gauge is locked securely, and it is advisable to "trail the work" into the saw blade. To accommodate crosscutting of extra wide work pieces, a front-table extension is available as an accessory. For ripping work beyond the capacity of the table, such as ripping a large panel (Fig. 15), the rip fence can be attached to the table extension.

Note that the table extension and tailstock fit on either end of the tubular ways. When applied to the left, or motor end, the greatest effective table area will be obtained.

CAUTION: To prevent accidents, do not leave saw blade on the spindle when the machine is not in use.

When using the circular saw, always use "push sticks" to feed work close to the blade. Keep a set of such sticks in different widths where they will be easily available. Always use the saw guard; it will slide smoothly over the work and protect the operator.

Re-check to see that carriage lever and knobs are tight before starting the saw.

Rotate the saw by hand, to check clearances before turning on the motor.

SAW ADJUSTMENTS—Miter-gauge slots on the saw table should be parallel to the saw blade; otherwise a true right-angle cannot be cut. Check by very carefully measuring the distance between the miter gauge and one tooth of the saw blade; then turn the blade to the opposite side and measure between the same tooth and the miter gauge. (The miter gauge stop-rod provides a simple and accurate means of making this measurement.) If the distance is not the same at front and back, the table must be "revolved."

To do this, loosen the four bolts underneath the table that hold it to the trunnion and table bearing. There is sufficient "play" to permit any adjustment the table might require. When alignment has been checked, tighten bolts.

To set trunnion stops, square the table to the sanding disc with a carpenter's square; tighten the trunnion wrench. Loosen the trunnion stop screw and press the trunnion stop pointer into the recess; tighten the screw. To check accuracy of miter gauge, lock it in the 90° position. Place it in right hand miter slot. Square the face of miter gauge with left hand miter slot using

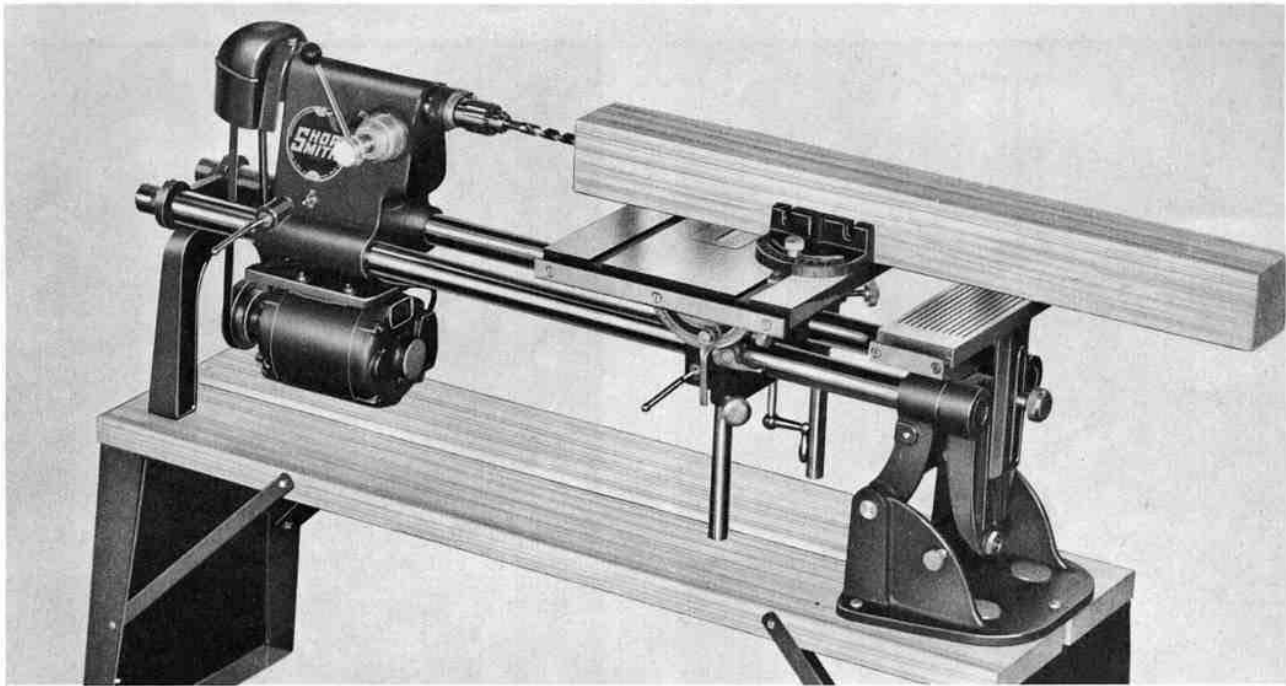

FIG. 19 Shopsmith set up as horizontal drill.

a carpenter's square. To adjust it, loosen thumb knob and set screw in indicator block and move miter gauge body right or left until square. Be sure in so moving that the spring ball-bearing stop stays in the 90° notch. When square, lock assembly with thumb knob and tighten set screw. See Fig. 16.

Rip fence should be parallel to the saw blade. When miter gauge slots have been checked (as above), the fence should be parallel to the slots. If adjustment should be necessary, loosen the two bolts in the rip fence base; correct alignment and tighten.

DISC SANDER

The 12-inch pressure-cast aluminum sanding disc (Fig. 17) fits directly onto the spindle tip. Be certain the setscrew is tightly applied against the spindle "flat." **Do not operate at excessive speed;** use "second" or intermediate speed, which is fast enough for most purposes.

The saw table is used as a work support. Set surface of the table about 1-inch below center of the disc. Edge of table should clear disc by about $\frac{1}{8}$ inch. Plain and compound miters are sanded by using the miter gauge, tilting the table, or both. New abrasive discs can be applied by stripping off the worn disc and holding a stick of adhesive against the revolving disc until evenly coated and then pressing fresh disc into even contact.

The headstock and carriage can be moved to the extreme right, which will give maximum operating convenience.

CAUTION: In sanding-disc operations, the table should always be horizontal or tilted away from the disc—never angle table into the disc.

HORIZONTAL DRILL PRESS

In addition to handling work too large or too awkward to be worked on a vertical drill press, Shopsmith, as a horizontal drill press, will do many jobs with greater precision and ease. Jacobs chuck is placed on the spindle and held in place by tightening its setscrew. Drills, reamers and other tools within the $\frac{1}{2}$ -inch capacity of the chuck are tightened or released by the accompanying chuck key.

CAUTION: Always be sure to remove key from chuck before applying power to motor.

Locate table at desired position on the ways and set for height with micro-table raising mechanism. The rip fence and miter gauge can be used either as guides or stops. For example: If it is required to drill a series of holes along the edge of a 1" x 12" plank (Fig. 18), adjust table so point of drill will center at required points and set the rip fence, as a guide, to bear against opposite side of the work. For end-drilling in long stock (Fig. 19), the work can be held to drill a true hole by clamping miter gauge to the table after the drill has been centered. When Shopsmith is used in its horizontal position, the feed lever should be screwed into the pinion shaft knob on the side nearest the operator, so that the drill feed can be made without reaching over the headstock.

The table extension can be used with the horizontal drill press by placing the tailstock upside down on the end of the ways. Then attach the table extension bracket to the tailstock, and the latter to the ways, with the bracket knob and studscrew.

VERTICAL DRILL PRESS

To change Shopsmith from any horizontal-operating unit to a vertical drill press, simply raise and lock the table at its highest position and swing it at a right angle to the ways (Fig. 20). Then release carriage knobs until table settles down against carriage. Move carriage to a point about 15 inches from base-plate arm and tighten carriage lever. (This point will vary according to the operator's height to give the most convenient operating level). Move headstock up until chuck is about 8 inches from the table and **lock headstock lever**. Check to see that the base-plate knob is unscrewed and unscrew the headrest knob. Grip the ways, with both hands, near the headrest and swing entire unit up to vertical position. Tighten base-plate knob. The feed lever can be used on either side and the drill press operated from the right or left at the operator's convenience.

Lock-nuts on the depth stop-rod can be set to control length of spindle stroke or boring depth. To use the depth of stroke gauge, extend the quill until the drill touches the workpiece; lock the quill in this position. Then turn the depth gauge collar

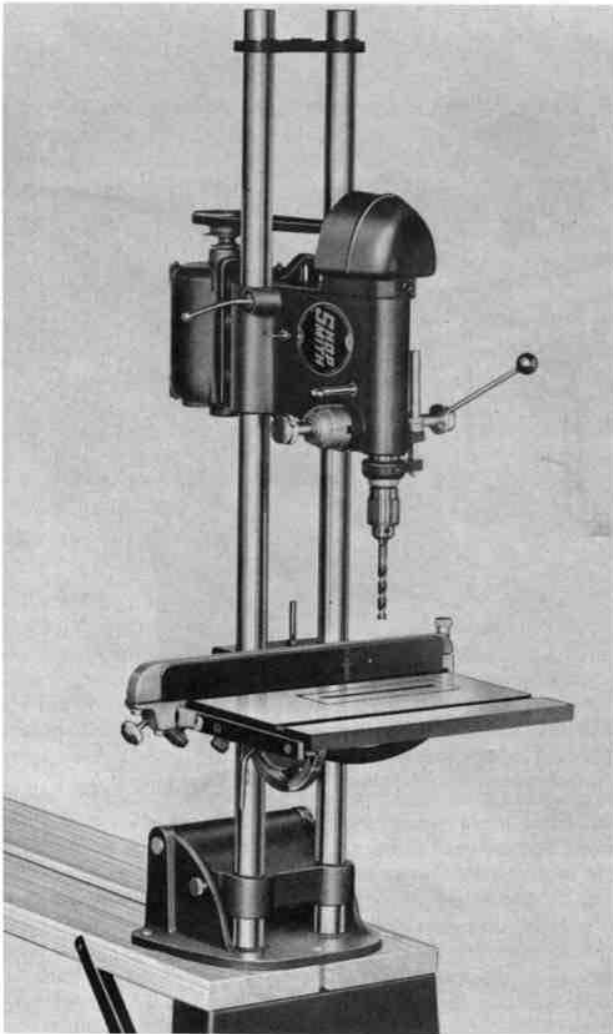

FIG. 20 Shopsmith set up as vertical drill press.

until the indicator points to zero. When the drill is further extended, the indicator will register the exact depth of cut. The quill lock-lever will hold the spindle at any extended position. The rip fence is a very useful guide for drilling a series of holes, or as part of a jig; the table will tilt to any desired angle.

It is advisable to use a piece of wood as a "pad" between the table and work to be drilled in order to prevent the table from being scarred.

CAUTION: When drilling metal, always support the work in a table vise or clamp, or clamp it securely to the table; do not attempt to hold such work in the hands. Re-check to be sure headstock lever and carriage lever are tight before raising to vertical drill-press position.

MISCELLANEOUS APPLICATIONS

BUFFING—Use buffing wheels on a Shopsmith $\frac{1}{2}$ -inch arbor (Fig. 21) and operate at high speed. Polishing compounds, such as tripoli, emery and rouge deposited on the ways should be carefully removed before sliding carriage or headstock.

SCRATCH BRUSHING—Steel or brass-wire scratch brushes in various degrees of fineness can be used to produce either a rough-textured or fine satin finish on metals, depending on type of brush and operating speed. Support on a Shopsmith $\frac{1}{2}$ -inch arbor.

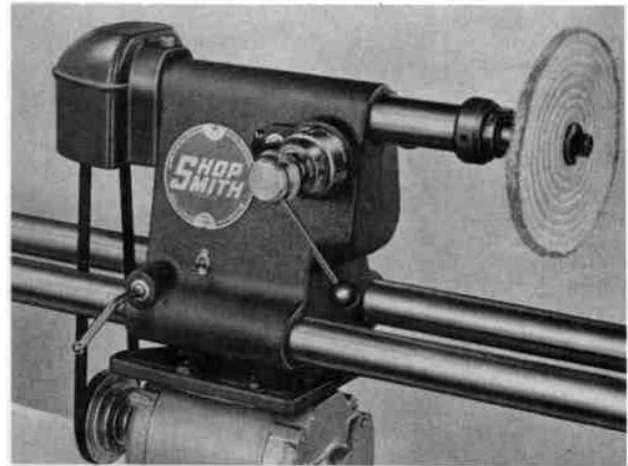

FIG. 21 Buffing wheel accessory (quill extended).

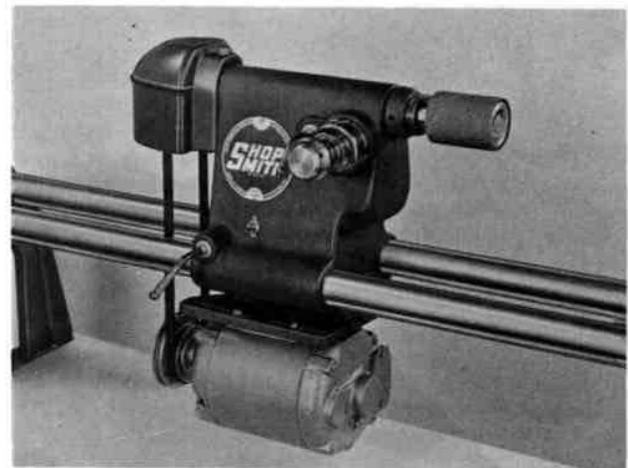

FIG. 22 Drum Sanding accessory—tool rest not shown.

DRUM SANDER—In either its horizontal or vertical position, Shopsmith can be used to excellent advantage as a drum sander (Fig. 22). Tool-rest can be used as a guide. The Shopsmith sanding drum, which fits "over" the spindle, is recommended. For precision type of surfacing or sanding, the Shopsmith shaper fence is recommended with sanding drum, see Fig. 23.

ROUTER—The large work table makes an excellent surface for routing and veining operations. Both the miter gauge and rip fence can be used as guides. Use a Shopsmith router chuck to hold router bits. (See Instructions packed with Accessory.)

SHAPER—Shopsmith can be used in either of two positions for shaping and molding: horizontal or vertical. Shopsmith shaper fence and arbors are available for this operation. (See Instructions packed with Accessory.)

FLEXIBLE SHAFT—Shopsmith makes a good source of power for a flexible shaft (Fig. 24). The table makes an excellent base for resting or clamping work when grinding, routing, buffing, etc.

MORTISING—With Shopsmith mortising attachment (Fig. 25) accurate mortising can be accomplished in either the horizontal or vertical position. (See Instructions packed with Accessory.)

JOINTING—Using the Shopsmith shaper fence, and $2\frac{1}{2}$ -inch

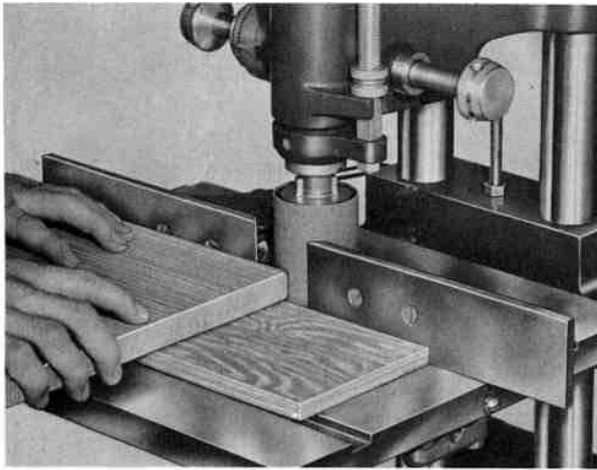

FIG. 23 Drum Sander in use with Shaper Fence attachment. (Board rest for workpiece is necessary, as shown)

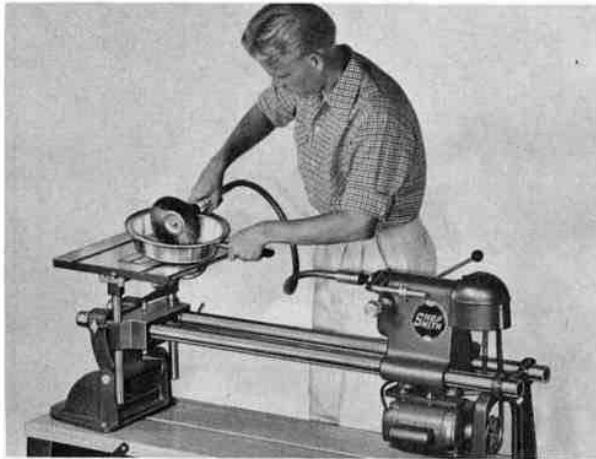

FIG. 24 Flexible Shaft accessory used with wire brush attached.

jointer-cutter, edging or light jointing can be easily performed in either the horizontal or vertical position.

SAFETY PRECAUTIONS

Most accidents, whether they occur in industry, on the farm, at home, or on the highway, are caused by the failure of some individual to follow simple and fundamental safety rules or precautions. For this reason most accidents can be prevented, by recognizing the real cause and doing something about it before the accident occurs. Regardless of the care used in the design and construction of any kind of equipment, there are many conditions that cannot be completely safeguarded against without interfering with reasonable accessibility and efficient operation.

A careful operator is the best insurance against an accident. The complete observance of **one simple rule** would prevent many thousand serious injuries each year. The rule is: **Never attempt to clean, oil or adjust machinery of any kind while it is under power or in motion.**

If your attention is distracted while operating any power tool, do two things first: 1. Turn off power; 2. Step away from the tool, then look.

Always follow these safety measures:

1. Never make any adjustment while the motor is running.
2. Keep belt guard on—this is extremely important in the

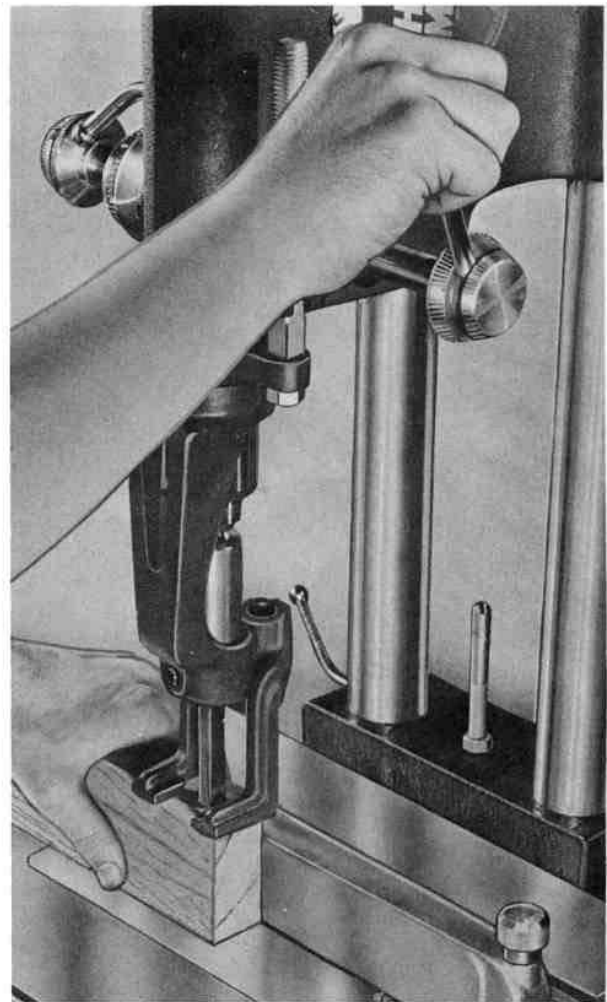

FIG. 25 Mortising accessories used with Shopsmith in vertical position.

vertical position to prevent operator's hair from getting in the pulley.

3. Do not wear loose clothing—ties, loose sleeves, etc.—when operating power machinery of any kind.
4. Do not allow small children close to the unit when motor is running. Better still, do not allow children in room while operating under power. Always pull out electric plug when the machine is left unattended as someone might turn on power.

REPAIRS

SHOPSMITH PARTS

Order repair and replacement parts from your Shopsmith dealer. Be sure to take him the following information:

1. Part Number, Name and Description of part (see list).
2. Model Number appears on name plate.
3. Complete Serial Number stamped on nameplate on head-stock.

Your Shopsmith dealer may have to order the part from the factory. If so, please allow sufficient time for transportation.

MOTORS

If your motor requires service, return it to your dealer who will have it repaired at the motor manufacturer's local repair station. Do not return motor to Magna Engineering Corporation.

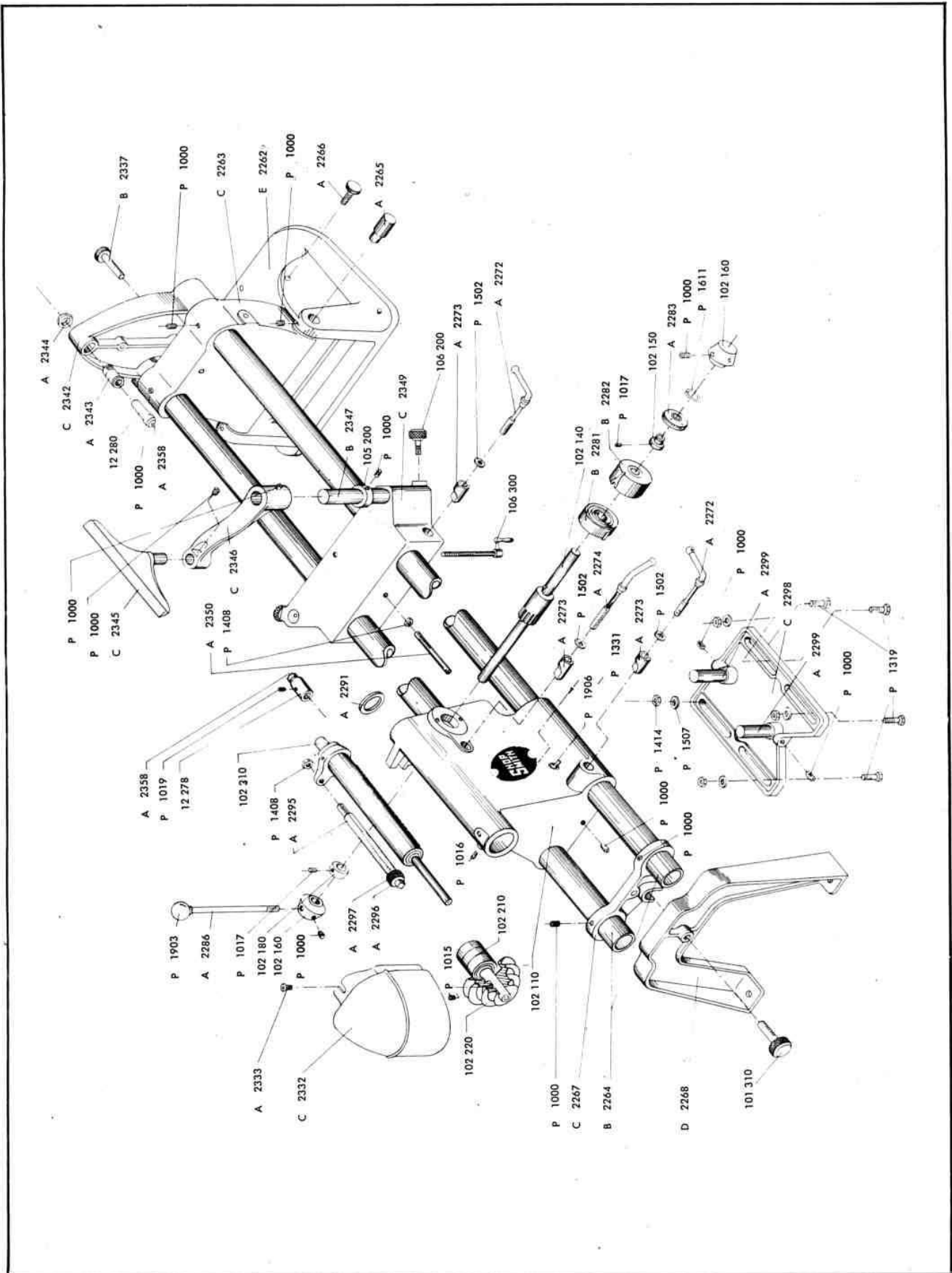

FIG. 27

MODEL 10-ER
REPAIR PARTS and ASSEMBLIES

PART OR ASMBLY. NO.	NAME AND DESCRIPTION	PRICE EACH	LBS.	OZS.
ASSEMBLIES				
101 310	Knob and Stud	\$1.00	—	10
102 110	Headstock	22.50	35	—
102 140	Feed Pinion	4.50	3	2
102 150	Collar60	—	6
102 160	Feed Knob	1.50	—	6
102 180	Feed Shaft Collar (3/4" Diam.)60	—	5
102 310	Quill	16.00	6	—
102 210	Sleeve	13.00	2	4
102 220	Headstock Pulley	1.25	1	—
103, 110	Tie Bar	7.25	6	—
103 310	Miter Gauge Casting	3.75	1	3
103 320	Miter Bar	2.25	1	3
103 420	Back Lock Knob65	—	10
103 430	Fence Base and Knob	2.00	1	—
103 610	Knob55	—	10
104 200	Extension Table Knob	1.25	—	10
105 200	Collar75	—	6
106 200	Rod Lock Knob75	—	8
106 300	Table Raiser Crank	1.65	—	10
107 100	Jacobs Chuck	7.50	1	12
108 100	Motor Pulley	1.25	1	—
12 001	SHOPSMITH Motor, 1/2 H.P., Ball Bearing, Capacitor, 1725 R.P.M., Complete	34.50	35	—
12 026	3/16" Allen Wrench20	—	3
12 027	1/8" Allen Wrench20	—	3
12 031	3/8" Saw Arbar	1.25	—	14
12 051	All Purpose Blade	4.75	1	—
12 101	Sanding Disc	3.95	3	—
12 278	Drive Center	1.25	—	7
12 280	Cup Center95	—	8
12 361	Table Insert95	—	8
PARTS				
P 1000	Screw—Socket Set (3/8"-16x1/2")10	—	3
P 1003	Screw—Socket Set (1/4"-20x1/2")10	—	3
P 1015	Screw—Socket Set (5/16"-18x1/2")10	—	3
P 1016	Screw—Socket Set (3/8"-16x3/8")10	—	3
P 1017	Screw—Socket Set (1/4"-20x1/4")10	—	3
P 1018	Screw—Flathead (10-24x1/2")05	—	3
P 1019	Screw—Socket Set (1/4"-28x1/4")10	—	3
P 1311	Screw—Oval Head (1/4"-20x7/16")05	—	3
P 1312	Bolt—Hex Head10	—	4
P 1313	Bolt—Hex Head (3/8"-16x1 1/4")10	—	4
P 1314	Screw—Round Head (1/4"-20x3/4")05	—	3
P 1315	Screw—Flathead (1/4"-20x3/4")10	—	3
P 1316	Bolt—Hex Head (1/4"-20x1 1/2")05	—	3
P 1317	Screw—Cap (3/8"-16x1" Hex Head)05	—	3
P 1318	Screw—Round Head (1/4"-20x1/2")05	—	3
P 1319	Screw—Cap (5/16"-18x1")05	—	3
P 1331	Screw—Round Head (8-32 x 1/2")05	—	2
P 1408	Nut—Hex (3/8"-16)05	—	3
P 1411	Nut—Hex (1/4"-20)05	—	3
P 1412	Nut—Light Hex (3/8"-24)05	—	3
P 1414	Nut—Hex (5/16"-18)05	—	3
P 1501	Washer (1/4" SAE Std.)05	—	3
P 1502	Washer (3/8" SAE Std.)05	—	3
P 1506	Washer—Lock (1/4"x3/32"x1/16" SAE)05	—	3
P 1507	Washer (5/16" Std.)05	—	3
P 1611	Retaining Ring15	—	2

PART OR ASMBLY. NO.	NAME AND DESCRIPTION	PRICE EACH	LBS.	OZS.
P 1703	V-Belt—38" O.D.	\$1.10	—	8
P 1903	Feed Lever Knob25	—	4
P 1904	Chuck Key75	—	6
P 1906	Motor Switch	1.50	—	4
E 2262	Base	13.50	30	—
C 2263	Arm	9.00	15	—
B 2264	Tubular Way	8.00	19	—
A 2265	Pin75	—	9
A 2266	Screw50	—	6
C 2267	Tie Bar	3.50	3	—
D 2268	Headrest	6.25	7	—
A 2272	Headstock Lever	1.00	—	7
A 2273	Head Lock Wedge75	—	6
A 2274	Quill Lock Lever	1.00	—	7
B 2281	Quill Spring	1.00	—	9
B 2282	Spring Housing90	—	10
A 2283	Depth Indicator90	—	6
A 2286	Feed Lever25	—	6
A 2291	Quill Bumper Ring20	—	3
A 2295	Gauge Rod75	—	12
A 2296	Nut—Gauge Rod15	—	3
A 2297	Gauge Rod Washer15	—	—
C 2298	Motor Bracket	4.00	5	—
A 2299	Bracket Rod50	—	11
A 2300	Table Rod	2.00	4	8
D 2303	Saw Table	18.25	15	—
C 2304	Fence Bar	2.00	1	8
A 2309	Stud10	—	3
A 2310	Knob—Small (1/4"-20 Tap)25	—	5
A 2311	Indicator25	—	3
A 2312	Indicator Button05	—	2
A 2313	Indicator Spring05	—	2
D 2315	Fence	6.50	4	—
B 2316	Fence Back Lock85	—	8
D 2321	Saw Guard	3.50	1	10
A 2322	Saw Splitter90	—	8
B 2323	Table Raiser Bar	1.65	—	17
C 2325	Trunnion	3.00	1	—
A 2326	Indicator Spacer15	—	4
A 2327	Spring10	—	2
A 2328	Trunnion Stop Lever	1.00	—	3
A 2329	Table Bracket60	—	6
A 2330	Trunnion Wrench75	—	5
A 2331	Collar—Stud Cap15	—	3
C 2332	Belt Guard	3.00	3	—
A 2333	Screw—Socket—Knurl15	—	3
A 2335	Stud15	—	3
C 2336	Extension Table Bracket	3.25	1	—
B 2337	Screw—Socket—Knurl60	—	8
D 2338	Extension Table	4.75	4	8
A 2339	Fence Bar	1.25	—	12
C 2342	Tailstock	7.00	11	—
A 2343	Floating Center	1.00	—	6
A 2344	Nut—Center Lock35	—	5
C 2345	Tool Rest	1.75	1	8
C 2346	Tool Rest Arm	2.00	3	—
B 2347	Tool Rest Post90	1	14
C 2349	Saw Table Carriage	9.50	15	—
A 2350	Stud15	—	6
A 2358	Center Pin10	—	3
A 9001	Owner's Guide25	—	6

SHOPSMITH ACCESSORIES

ACCESSORY NO.	DESCRIPTION	LIST PRICE	LBS.	OZS.
11 100	Jigsaw	\$34.95	21	—
11 300	Speed Changer	13.95	5	2
11 400	Shaper Fence	9.95	4	4
12 001	½ H. P. Special Motor	34.50	35	—
12 002	¾ H. P. Special Motor	45.95	45	—
12 007	Metal Bench Ends (Pair)	9.95	22	—
12 008	Retractable Casters	11.95	10	10
12 011	SHOPSMITH Cover	5.95	3	—
12 013	Lamp Attachment	4.45	2	—
12 015	Key Switch	1.75	—	6
12 026	3/16" Allen Wrench20	—	4
12 027	½" Allen Wrench20	—	4
12 030	½" Arbor	1.25	—	15
12 031	¾" Arbor	1.25	—	15
12 035	13/16" Headstock Pulley (2-Step)	1.25	—	12
12 039	¾" Motor Pulley (3-Step)	1.25	1	—
12 048	Magna-Lube—SHOPSMITH Grease50	—	4
12 049	Rust Preventive Spray	1.45	1	—
12 051	8" Saw Blade—All Purpose	3.45	1	—
12 053	8" Saw Blade—Hollow Ground Comb... ..	5.45	1	—
12 054	8" Saw Blade—Crosscut	3.45	1	—
12 055	8" Saw Blade—Rip	3.45	1	—
12 056	8" Saw Blade—8 Tooth	3.45	1	—
12 063	6" Dado Blade	14.95	3	8
12 067	8" Flexible Metal Cut-Off Wheel	2.95	—	12
12 076	Jigsaw Blades—5"—Packages of 6 .028" thick x .250" wide, 7 teeth45	—	1
12 077	.020" thick x .110" wide, 15 teeth30	—	1
12 078	.010" thick x .040" wide, 18 teeth35	—	1
12 079	.012" thick x .023" wide, 20 teeth30	—	1
12 081	.020" thick x .070" wide, 7 teeth35	—	1
12 082	.010" thick x .070" wide, 14 teeth30	—	1
12 084	.020" thick x .110" wide, 20 teeth30	—	1
12 085	.028" thick x .250" wide, 20 teeth45	—	1
12 095	Jigsaw Machine Files (Set of 6)	4.95	—	5
12 101	12" Sanding Disc	3.95	2	8
12 104	Distic Adhesive50	—	10
12 106	Liquid Adhesive95	—	8
12 110	12" Sandpaper—Assorted (Pkg. of 6)....	1.65	1	12
12 111	12" Sandpaper—Coarse (Pkg. of 6)	1.65	1	12
12 112	12" Sandpaper—Medium (Pkg. of 6)	1.65	1	12
12 113	12" Sandpaper—Fine (Pkg. of 6)	1.65	1	12
12 126	Drum Sander	2.95	1	4
12 134	Drum Sander Sleeves—Asstd. (Pkg. of 6)	1.10	—	7
12 135	Drum Sander Sleeves—Coarse (Pkg. of 6)	1.10	—	7
12 136	Drum Sander Sleeves—Med. (Pkg. of 6) ..	1.10	—	7
12 137	Drum Sander Sleeves—Fine (Pkg. of 6)....	1.10	—	7
12 151	Mortising Attachment	3.95	2	10
12 152	Mortising Hold Down	1.95	1	7
12 160	¼" Mortising Chisel	\$3.50	—	4
12 161	¾" Mortising Chisel	3.50	—	4
12 162	½" Mortising Chisel	3.50	—	4
12 163	⅜" Mortising Chisel	3.50	—	4
12 165	¼" Mortising Bit	1.85	—	4
12 166	¾" Mortising Bit	1.85	—	4
12 167	½" Mortising Bit	1.85	—	4

ACCESSORY NO.	DESCRIPTION	LIST PRICE	LBS.	OZS.
12 168	⅜" Mortising Bit.....	1.85	—	4
12 180	¼" Router Bit (½" Diam. Shank)	1.45	—	4
12 181	5/16" Router Bit (½" Diam. Shank)	1.45	—	4
12 182	¾" Router Bit (½" Diam. Shank)	1.45	—	4
12 183	½" Router Bit (½" Diam. Shank)	1.45	—	4
12 190	¼" Router Chuck	1.25	—	10
12 191	5/16" Router Chuck	1.25	—	10
12 193	½" Router Chuck	1.25	—	10
12 201	Auger Bits (Set of 5)	6.60	1	—
12 230	2½" Jointer-Cutter	9.95	1	5
12 232	½" Shaper Adapter	1.25	—	6
12 233	5/16" Shaper Adapter	1.25	—	5
12 235	Shaper Collars (Set of 4)	1.45	1	8
See Accessory Catalog	Shaper Cutters (15 different profiles) Each	1.95	—	2
12 276	Screw Center	1.25	—	6
12 281	Tailstock Chuck Arbor	1.25	—	7
12 282	Tailstock Live Center	3.25	—	12
12 283	½" Motor Pulley.....	1.25	1	1
12 290	3¼" Face Plate	1.50	1	—
12 291	6" Face Plate	2.75	1	12
12 301	Lathe Chisels (Set of 5)	7.95	2	14
12 311	Carbide Lathe Chisels (Set of 4)	14.95	1	10
12 312	⅛" Carbide Lathe Chisel—Square Nose..	3.95	—	6
12 313	¼" Carbide Lathe Chisel—Square Nose..	3.95	—	6
12 316	⅝" Carbide Lathe Chisel—Round Nose..	3.95	—	6
12 317	¾" Carbide Lathe Chisel—Round Nose ..	3.95	—	6
12 326	Flexible Shaft	15.95	5	6
12 329	Flexible Shaft Adapter95	—	6
12 330	6" Buffing Wheel75	—	4
12 331	6" Wire Brush—Fine	1.50	—	7
12 332	6" Wire Brush—Coarse	1.25	—	8
12 345	Lambswool Polishing Pad (for 6" Face Plate)	1.50	—	4
12 347	Lambswool Polishing Bonnet (for Sanding Drum)	1.25	—	4
12 351	Front Table Extension	2.75	1	—
12 355	Miter Gauge Stop Rod	1.25	—	10
12 356	Miter Gauge Extension	1.25	—	15
12 360	Table Insert—Dado Slot95	—	8
12 361	Table Insert—Saw Slot95	—	8
12 362	Table Insert—No Slot95	—	8

COMPLETE ASSEMBLIES

102 000	Headstock Assembly	84.50	45	—
102 310	Quill Assembly	16.00	6	—
102 210	Sleeve Assembly	13.00	2	4
103 200	Saw Table Assembly	24.50	18	—
103 300	Miter Gauge Assembly	5.50	2	6
103 400	Fence Assembly	9.00	2	5
103 800	Trunnion and Parts	6.00	1	8
104 000	Extension Table Assembly	9.50	3	5
104 300	Tailstock Assembly	8.50	11	6

SHOPSMITH ACCESSORIES

Sold only through your Local Dealer



SPEED CHANGER

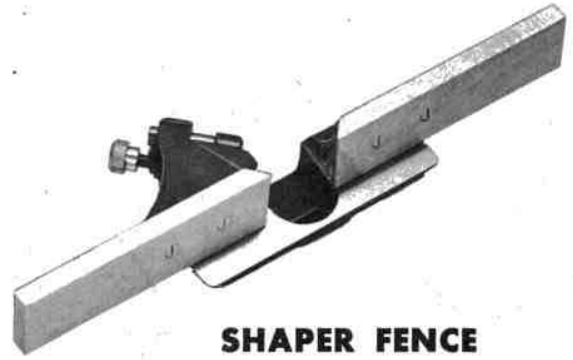

SHAPER FENCE

MORTISING ATTACHMENT



MORTISING HOLD DOWN



FRONT TABLE EXTENSION

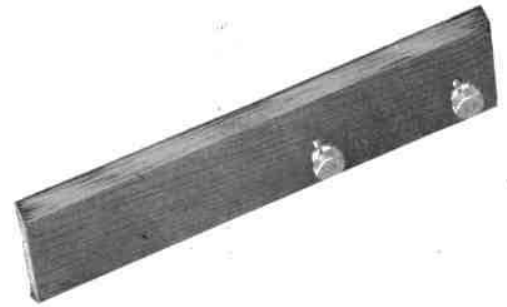

MITER GAUGE EXTENSION

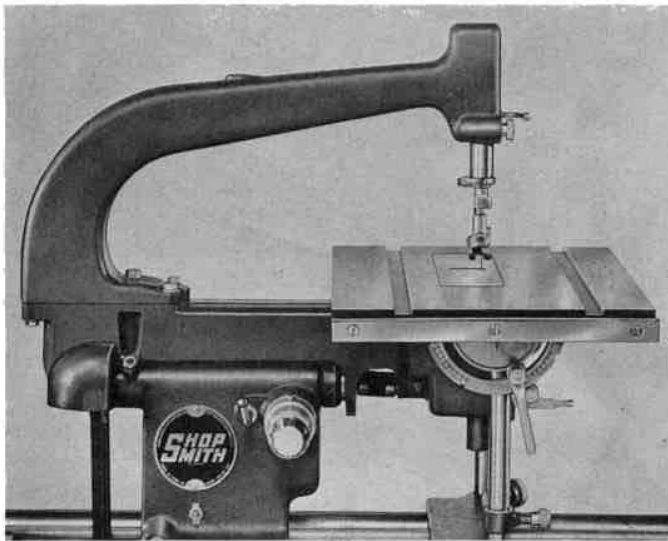

18" JIGSAW—Only \$34.95, but because you have a Shopsmith its the finest jigsaw you could own.

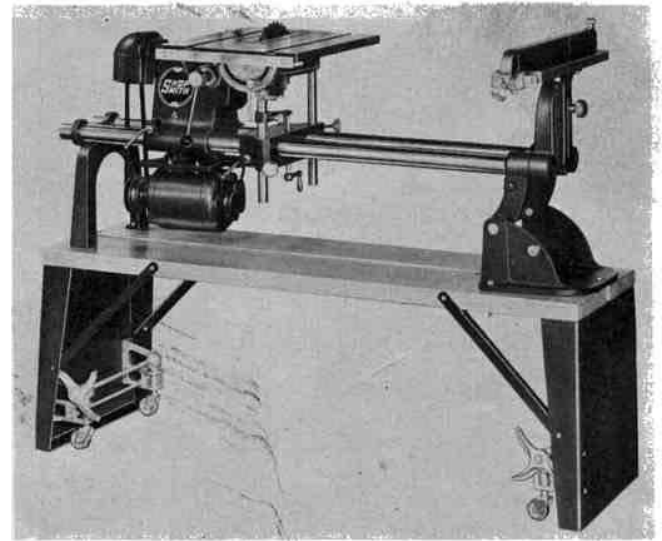

SHOPSMITH RETRACTABLE CASTER ASSEMBLY

20

Magna Engineering Corporation reserves the right to make changes or improvements on SHOPSMITH or accessories without incurring any obligation to make similar changes or improvements on machines previously sold.